



el**torrent**

eltorrent

INSPIRATION

An aerial photograph of a small village nestled in a lush green valley. The village features traditional stone buildings with terracotta roofs. The surrounding landscape is a mix of green fields, trees, and a winding road. In the background, there are rolling hills and mountains under a clear blue sky. The word 'INSPIRATION' is overlaid in large, white, sans-serif capital letters on the left side of the image.

We bring our designs and lighting projects to life by creating synergy with nature in this wonderful setting, a great source of inspiration. This is a team effort in which imagination and art merge together.

Dentro de este marco privilegiado que es nuestra mejor fuente de inspiración, y creando sinergia con la naturaleza, damos vida a nuestros diseños y proyectos de iluminación. Un trabajo en equipo donde se mezclan imaginación arte.

In diesem erlesenen Rahmen, der unsere beste Inspirationsquelle darstellt, schaffen wir Synergien mit der Natur, hier werden unsere Beleuchtungsdesigns und Projekte geboren. Eine Arbeit im Team, bei der Fantasie und Kunst miteinander verschmelzen.

C'est dans ce cadre privilégié, notre première source d'inspiration, que nous donnons naissance à nos créations et à nos projets de luminaires, toujours en synergie avec la nature. Un travail en équipe qui invite à mêler art et imagination.

DESIGN- NERS

Experimental, multi-faceted. I like to reinvent what already exists. Pure sensitivity and creativity.

Experimental, polifacético. Me gusta reinventar lo que ya existe. Pura sensibilidad y creatividad.

Experimentell, vielseitig. Ich liebe es, vorhandenes neu zu gestalten. Sensibilität und Kreativität pur.

Expérimental, éclectique. J'aime revisiter ce qui existe déjà. Sensibilité pure et créativité.

ELOY PUIG



Curiosity for the new and a passion for light. Always experimenting with new materials to create objects with their own identity and free of their own iconography, returned to their purest essence.

Curiosidad por lo nuevo y pasión por la luz. Experimentar siempre con nuevos materiales para obtener objetos con identidad propia desvinculados de su propia iconografía y devolverlos al estado más puro.

Neugier auf Neues und Begeisterung für das Licht. Stets mit neuen Materialien zu experimentieren um Objekte mit eigener Identität zu schaffen, die von ihrer eigentlichen Inhaltsdeutung abgekoppelt sind, und sie wieder ihrem reinsten Zustand zuzuführen.

Curieux de nouveauté et passionné de lumière. Expérimenter sans cesse de nouveaux matériaux pour créer des objets uniques, loin de leur propre iconographie et en retrouver l'essence même.

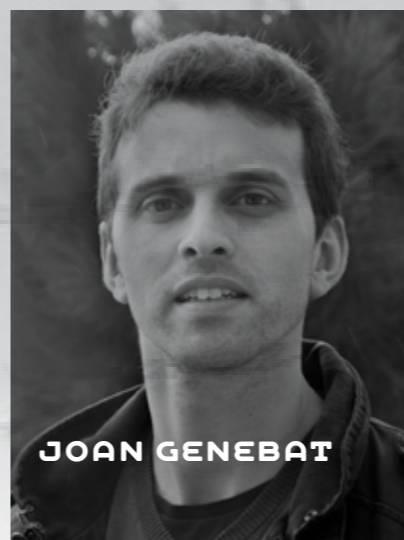

JOAN GENEBAT



ANDREU CARULLA

The challenge and main objective is to successfully convey the desired sensations. Light has starkly contrasting characters and personalities; they are discovered little by little.

Conseguir transmitir las sensaciones que se quieren contar es el reto y el objetivo más grande. La luz tiene caracteres y personalidades muy diferentes, se van conociendo poco a poco.

Die Herausforderung und das höchste Ziel bestehen darin, die Eindrücke vermitteln zu können, die man bewirken möchte. Das Licht hat ganz unterschiedliche Charaktere und Persönlichkeiten, die Schritt für Schritt erkundet werden.

Parvenir à transmettre les sensations désirées est un défi et aussi le plus bel objectif. La lumière a des caractères et des personnalités multiples ; peu à peu ils se rapprochent.



STIMULO TEAM

We enjoy creating new, stimulating products and receiving feedback from people all over the world...

Nos gusta crear nuevos productos que estimulen. Recibir el feedback de cualquier parte del mundo, de la gente...

Wir schaffen gerne neue und stimulierende Produkte. Und freuen uns über Feedback aus allen Teilen der Welt, von den Menschen...

Nous aimons créer de nouveaux produits qui éveillent les sens. Avoir des retours de partout dans le monde, des gens...

Hand- made

Our lights are handmade with total dedication, as required by the projects and exclusive combinations imagined by our customers.

When you purchase an El Torrent light you become the owner of a unique item equipped with the latest technology and a subtle design that transmits warmth and comfort in any setting.

Craftsmanship and innovation converge and form part of each and every one of our items.

Nuestras luminarias están hechas a mano con total dedicación, tal como requieren los proyectos y las combinaciones exclusivas imaginadas por nuestros clientes.

Quien adquiera una luminaria de El Torrent posee un elemento único, con la tecnología más actual y un diseño sutil que transmitirá calidez y confort al ambiente en que se encuentre.

Artesanía e innovación se unen y forman parte de cada una de nuestras piezas.

Unsere Leuchten werden sorgfältig von Hand angefertigt und auf die jeweiligen Projekte und Kombinationen abgestimmt, die unsere Kunden sich ausmalen.

Wer eine Leuchte von El Torrent erwirbt, besitzt ein einmaliges Stück mit der neuesten Technologie und einem raffinierten Design, das dem umgebenden Raum Wärme und Komfort verleiht.

Handwerk und Innovation verbinden sich und sind fester Bestandteil aller unserer Objekte.

Nos luminaires sont fabriqués à la main avec le plus grand soin, ce soin qu'exigent les projets et les associations exclusives imaginées par nos clients.

Qui fait le choix d'un luminaire El Torrent fait le choix d'un objet unique doté de la dernière technologie et d'un style raffiné, qui transmettra chaleur et confort là où il se trouve.

Artisanat et innovation s'unissent et font partie intégrante de chacune de nos pièces.

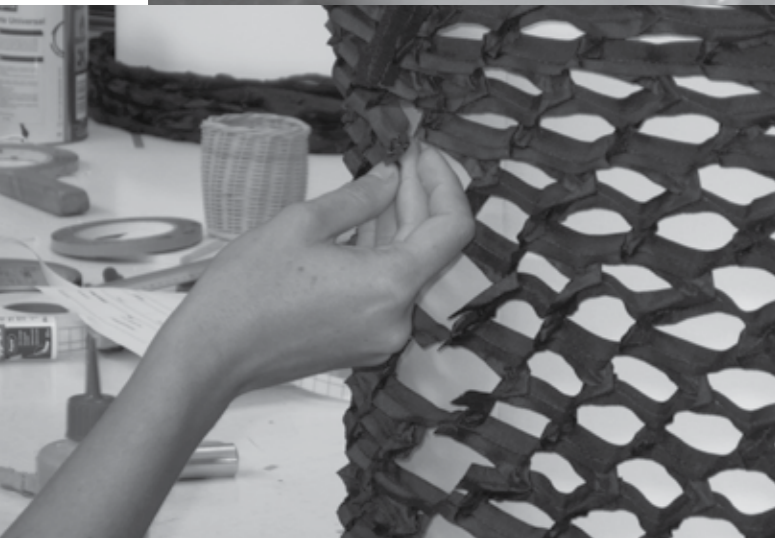

INDEX

HANGING LAMPS - COLGANTES

| | | | |
|--------------|-----|-----------|-----|
| AFRO | 216 | | |
| ANDREA | 208 | | |
| ANKARA | 140 | | |
| ARCA | 204 | | |
| AROS | 252 | | |
| AROS 2X | 256 | | |
| AROS DOBLES | 264 | | |
| AROS TRIPLES | 268 | | |
| AYDA | 232 | | |
| BERTA | 132 | | |
| BRUNZ | 100 | NEO | 164 |
| CITRIC | 96 | NEX | 84 |
| CITY | 114 | NONA | 126 |
| CONET | 280 | ODA | 46 |
| DAYA | 192 | ORGANIC | 26 |
| DOUCE | 170 | OVLA | 236 |
| DUNA | 72 | SLIM | 54 |
| ELSA | 80 | SMOOTH | 88 |
| EVA | 50 | SONORA | 104 |
| FLOCK | 92 | SQUARE | 240 |
| FLUX | 20 | SQUARE 2X | 244 |
| GEMMA | 68 | SUITE | 200 |
| KEOPS | 212 | SYLVA | 196 |
| KOORALBYN | 108 | TRUDY | 120 |
| KOORD | 12 | TUAREG | 34 |
| LIA | 184 | TUBS | 272 |
| NAGAR | 228 | VERSATIL | 62 |

CEILING LAMPS - PLAFONES

| | |
|-----------|-----|
| AROS | 260 |
| AROS 2X | 260 |
| DAYA | 192 |
| PETAL | 40 |
| SLIM | 54 |
| SQUARE | 248 |
| SQUARE 2X | 248 |
| TUAREG | 34 |

FLOOR LAMPS - PIE

| | |
|---------|-----|
| ANKARA | 140 |
| BERTA | 132 |
| CITY | 114 |
| DONNA | 150 |
| DOUCE | 170 |
| FLOCK | 92 |
| LIA | 184 |
| NATUR | 160 |
| NEO | 164 |
| NONA | 126 |
| NUVIA | 180 |
| OBELISK | 220 |
| ORGANIC | 26 |
| SERENA | 146 |
| TELMA | 176 |
| TRUDY | 120 |
| TUAREG | 34 |
| TUBS | 272 |
| XÈNIA | 154 |

TABLE LAMPS - SOBREMESA

| | |
|-----------|-----|
| AFRO | 216 |
| ANKARA | 140 |
| BERTA | 132 |
| CITY | 114 |
| DONNA | 150 |
| DOUCE | 170 |
| HALL | 224 |
| KOORALBYN | 108 |
| LIA | 184 |
| NATUR | 160 |
| NEO | 164 |
| NONA | 126 |
| NUVIA | 180 |
| OBELISK | 220 |
| ORGANIC | 26 |
| SERENA | 146 |
| SUITE | 200 |
| TELMA | 176 |
| TREBOLA | 76 |
| TRUDY | 120 |
| XÈNIA | 154 |

WALL LAMPS - APLIQUES

| | |
|----------|-----|
| ANKARA | 140 |
| APLIQUES | 286 |
| CITRIC | 96 |
| DOUCE | 170 |
| GEMMA | 68 |
| LIA | 184 |
| NEO | 164 |
| ORGANIC | 26 |
| XÈNIA | 154 |

OTHER - OTROS

| | |
|----------------|-----|
| CUSTOMIZATION | 296 |
| DESIGNERS | 6 |
| MATERIALS - A | 298 |
| MATERIALS - B | 300 |
| MATERIALS - C | 303 |
| MATERIALS - D | 305 |
| MATERIALS - SP | 307 |
| HANDMADE | 8 |
| INSPIRATION | 4 |
| SUPPORTS | 308 |



KOORD

Eloy Puig





COLOR CARD FOR PROJECTS



For orders of at least 6 identical items, any colour from the chart may be chosen.

A partir de 6 piezas iguales se puede escoger cualquier color de la carta

Ab 6 gleichen Teilen kann jede Farbe aus der Farbpalette ausgewählt werden.

À partir de 6 pièces identiques, il est possible de choisir parmi les couleurs de la carte

KOORD

Eloy Puig

CE    IP20

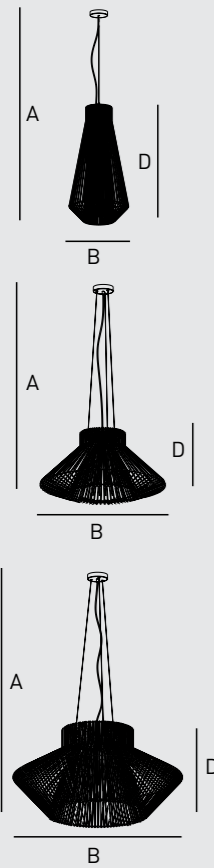

| ref | A | BØ | C | D | DIF |  |  |
|------------------|-------|-------|---|------|-----|--|---|
| KD.001 | 180cm | 40cm | | 80cm | | 1xE27 PL E-GLOBE 32W | 1xE27 ECO GLOBE 42W |
| KD.001.14 | 180cm | 40cm | | 80cm | | 1xMODULE LED 17W 1000Lm 2900°K  | |
| ref | A | BØ | C | D | DIF |  |  |
| KD.002 | 165cm | 70cm | | 35cm | | 1xE27 PL E-GLOBE 32W | 1xE27 ECO GLOBE 42W |
| KD.002.14 | 165cm | 70cm | | 35cm | | 1xMODULE LED 17W 1000Lm 2900°K  | |
| ref | A | BØ | C | D | DIF |  |  |
| KD.003 | 180cm | 100cm | | 50cm | | 3xE27 PL E-GLOBE 32W | 3xE27 ECO GLOBE 42W |
| KD.003.14 | 180cm | 100cm | | 50cm | | 1xMODULE LED 17W 1000Lm 2900°K  | |

Nickel pendant lamp. Lampshade with braided acrylic cord available in different colours. Lit with LEDs or E-27.

Colgante en níquel. Pantalla en cordón trenzado acrílico de colores, iluminación por leds o E-27

Hängelampe aus Nickel. Schirm aus geflochtener, farbiger Acrylschnur, Leuchtmittel LED oder E-27.

Suspension en nickel. Abat-jour en ficelle acrylique tressée de couleurs, éclairage à LED ou E-27

STANDARD COLORS



braided acrylic cord available in different colours
cordón trenzado acrílico de colores
Geflochtene, farbige Acrylschnur
ficelle acrylique tressée de couleurs



FLUX

Andreu Carulla





FLUX

Andreu Carulla

CE    IP20

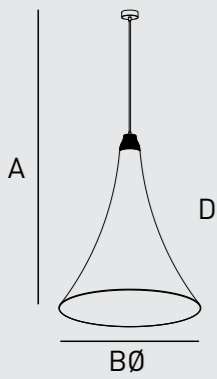

| ref | ref | A | BØ | C | D | DIF | |
|--------|--------|-------|------|---|------|-----|----------------------------------|
| FX.001 | FX.003 | 150cm | 70cm | | 40cm | ✓ | 1xMODULE LED 17W - 1000Lm 2900°K |
| FX.002 | FX.004 | 200cm | 70cm | | 80cm | ✓ | 1xMODULE LED 17W - 1000Lm 2900°K |

A+ 

Black metal pendant lamp with 17W LED light source, lampshade in elastic and reflective technical fabric.

colgante en metal negro con fuente de luz led de 17W, pantalla en tejido técnico elástico y reflectante.

Hängelampe aus schwarzem Metall mit LED-Leuchtmittel 17W, Schirm aus elastischem technischem Gewebe, reflektierend.

Suspension en métal noir, éclairage à LED 17 W, abat-jour en tissu technique élastique et réfléchissant.





Eloy Puig & Joan Genebat

ORGANIC







ORGANIC

Eloy Puig & Joan Genebat

CE V F IP20

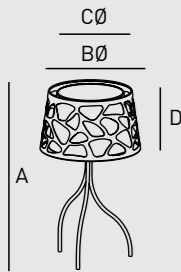

| ref | ref | A | BØ | CØ | D | DIF | A | A+ | B |
|--------|--------|-------|------|------|------|-----|----------------|---------------|---------------------|
| 0G.009 | 0G.011 | 54cm | 30cm | 25cm | 18cm | ✓ | 1xE-27 FLC 25W | 1xE27 LED 12W | 1xE-27 P45 ECO 24 W |
| 0G.001 | 0G.005 | 165cm | 60cm | 50cm | 35cm | ✓ | 1xE-27 FLC 25w | 1xE27 LED 12W | 1xE-27 A60 ECO 42W |

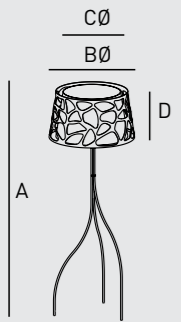

□ Floor lamp with metal body available in black or off-white. Double shade in die-cut fabric on the outside and iridescent polyester on the inside.

Modelo de pie con cuerpo metálico en negro o blanco roto. Doble pantalla en textil troquelada y poliéster metalizado iridiscente.

Ausführung als Stehleuchte mit Metallkörper, lieferbar in Schwarz oder gebrochenem Weiß. Gestanzter, doppelter Lampenschirm aus Stoff außen und irisierendem Polyester innen.

Modèle sur pied avec corps métallique disponible en noir ou en blanc cassé. Abat-jour double embouti avec extérieur en textile et intérieur en polyester irisé.

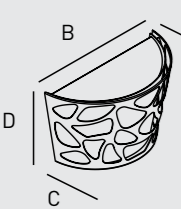

| ref | ref | A | B | C | D | DIF | A+ |
|--------|--------|------|------|------|------|-----|--------------------------------|
| 0G.010 | 0G.012 | 15cm | 35cm | 12cm | 20cm | ✓ | 1xMODULO LED 13W 900 Lm 2900°K |

⊕ Black or off-white metal wall light. Double shade in die-cut fabric and iridescent metallic polyester.

Aplique metálico en negro o blanco roto. Doble pantalla en textil troquelada y poliéster metalizado iridiscente.

Wandlampe aus Metall in schwarz oder gebrochenem weiß. Doppelwandiger Schirm aus ausgestanztem Textilgewebe und irisierend metallisiertem Polyester.

Applique métallique noire ou blanc cassé. Double abat-jour en tissu ajouré et polyester métallisé iridescent.



| ref | ref | A | BØ | CØ | D | DIF | A | A+ | B |
|--------|--------|-------|------|------|------|-----|----------------|---------------|--------------------|
| 0G.002 | 0G.006 | 145cm | 40cm | 35cm | 27cm | ✓ | 1xE-27 FLC 25w | 1xE27 LED 12W | 1xE-27 A60 ECO 42W |
| 0G.003 | 0G.007 | 150cm | 60cm | 50cm | 35cm | ✓ | 3xE-27 FLC 25W | 3xE27 LED 12W | 3xE-27 A60 ECO 42W |
| 0G.004 | 0G.008 | 155cm | 80cm | 70cm | 40cm | ✓ | 3xE-27 FLC 25W | 3xE27 LED 12W | 3xE-27 A60 ECO 42W |

⊕ Pendant lamp with metal canopy available in black or off-white. Double shade in die-cut fabric on the outside and iridescent polyester on the inside.

Colgante con florón metálico en negro o blanco roto. Doble pantalla en textil troquelada y poliéster metalizado iridiscente.

Hängeleuchte mit Metallrosette, lieferbar in Schwarz oder gebrochenem Weiß. Gestanzter, doppelter Lampenschirm aus Stoff außen und irisierendem Polyester innen.

Suspension avec fl euron en métal disponible en noir et en blanc cassé. Abat-jour double embouti avec extérieur en textile et intérieur en polyester irisé.

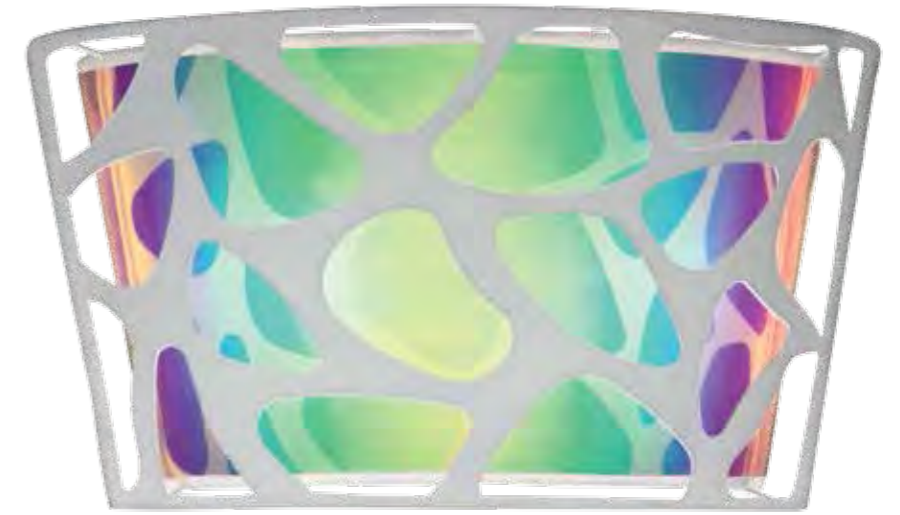

MATERIALS



embroidered organdie
organza bordada
bestickter Organza
organza brodé
p 298

PROJECT



La boutique de Coiffeur
France
p 60

TUA REG

Eloy Puig & Joan Genebat







TUAREG

Eloy Puig & Joan Genebat

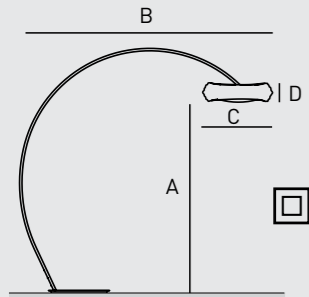
CE V  IP20



| ref | ref | ref | A | B | C0 | D | DIF | |
|--------|--------|--------|-------|-------|------|------|-----|---|
| TG.001 | TG.002 | TG.003 | 190cm | 195cm | 62cm | 17cm | ✓ |  1XT5C 60W |

 Floor lamp with metal body, polyester shade and methacrylate diffuser. Available in black, off-white and red.

Modelo de pie con cuerpo metálico, pantalla en poliéster y difusor en metacrilato. Disponible en Negro, Blanco roto y Rojo.

Ausführung als Stehleuchte mit Metallkörper, Schirm aus Polyester und Streuscheibe aus Methacrylat. Lieferbar in Schwarz, gebrochenem Weiß und Rot.

Modèle sur pied avec corps métallique, abat-jour en polyester et diffuseur en méthacrylate. Disponible en noir, en blanc cassé et en rouge.

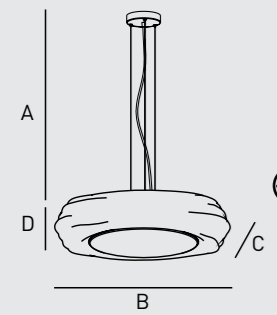

| ref | ref | ref | A | B0 | C | D | DIF | |
|--------|--------|--------|-------|------|------|------|-----|---|
| TG.004 | TG.005 | TG.006 | 135cm | 62cm | 52cm | 17cm | ✓ |  1XT5C 60W |

 Pendant lamp with satin nickel canopy and polyester shade with methacrylate diffuser. Available in black with red fabric cable, and in off-white and red with black fabric cable.

Colgante con florón en niquel satinado. Pantalla en poliéster con difusor en metacrilato y cable textil. Disponible en Negro, Blanco roto y Rojo.

Hängeleuchte mit Rosette aus satiniertem Nickel, Schirm aus Polyester und Streuscheibe aus Methacrylat. Lieferbar in Schwarz mit rotem Stoffkabel sowie in gebrochenem Weiß und Rot mit schwarzem Stoffkabel.

Suspensión avec fl euron en nickel satiné et abat-jour en polyester avec diffuseur en méthacrylate. Disponible en noir avec câble textile rouge, et en blanc cassé et en rouge avec câble textile noir.

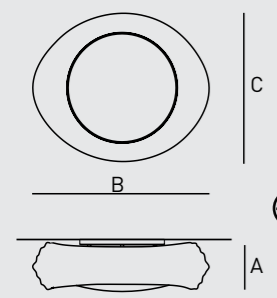

| ref | ref | ref | A | B | C | D | DIF | |
|--------|--------|--------|------|------|------|---|-----|---|
| TG.007 | TG.008 | TG.009 | 18cm | 62cm | 52cm | | ✓ |  1XT5C 60W |

 Polyester ceiling lamp and methacrylate diffuser. Available in black, off-white and red.

Plafón en poliéster y difusor en metacrilato. Disponible en Negro, Blanco roto y Rojo.

Deckenleuchte aus Polyester und Streuscheibe aus Methacrylat Lieferbar in Schwarz, gebrochenem Weiß und Rot.

Plafonnier en polyester et diffuseur en méthacrylate. Disponible en noir, en blanc cassé et en rouge.

PROJECT



Cantina
Norway

p 60

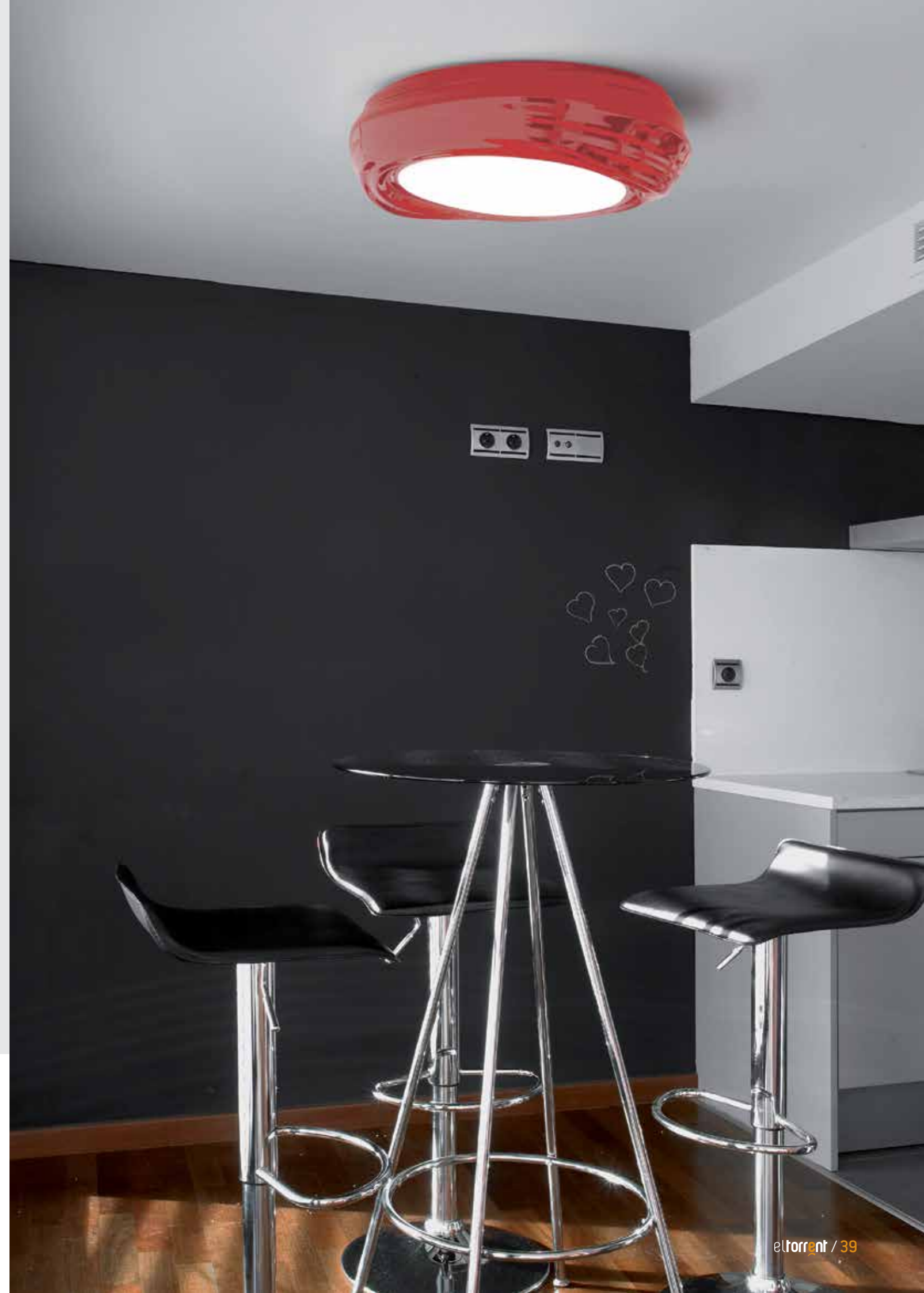



PETAL

Eloy Puig



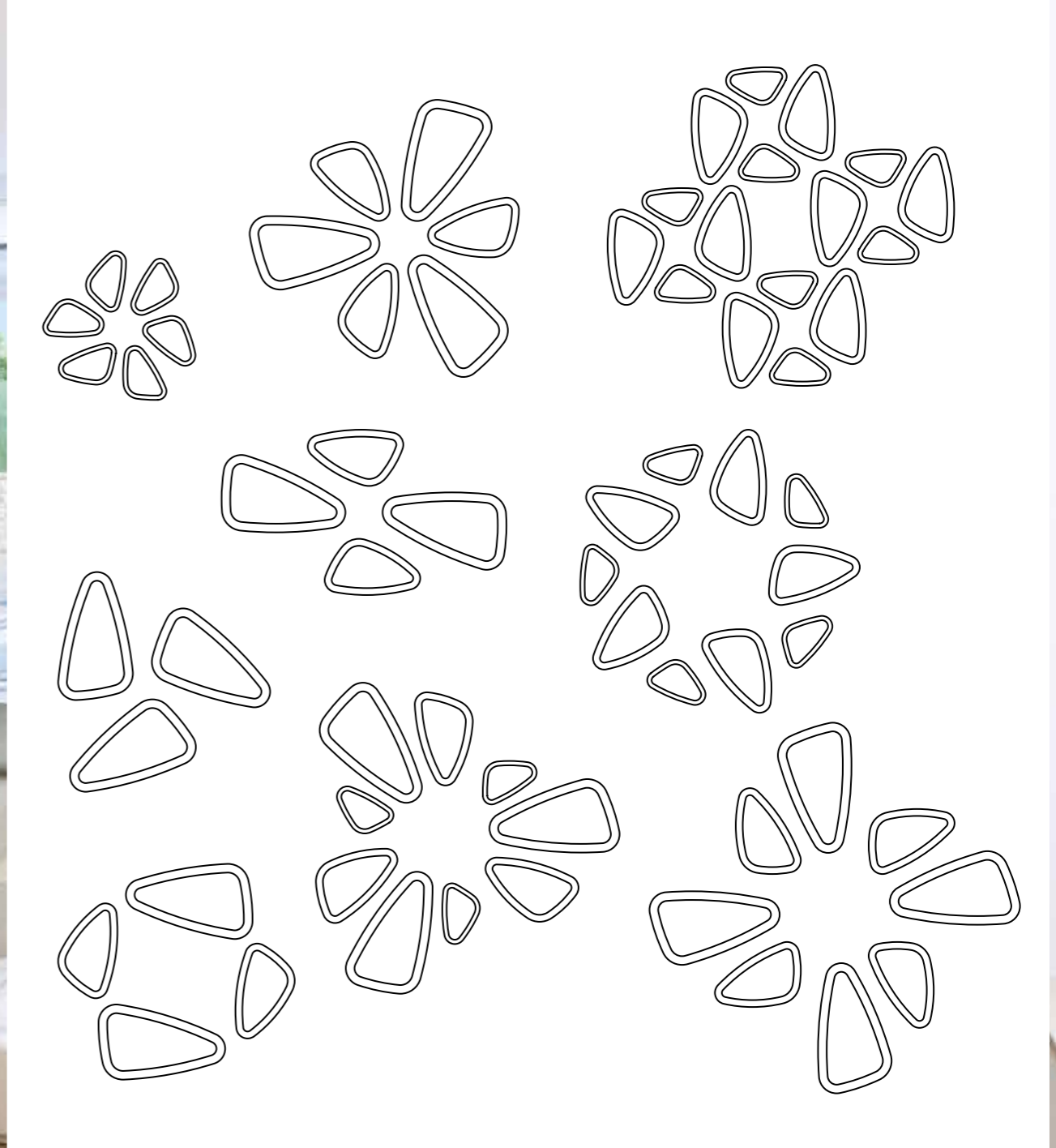

PETAL

Eloy Puig

CE    IP20

| ref | A | B | C | D | DIF | A  |
|------------|------|-------|------|---|-----|---|
| PT.001C | 18cm | 70cm | 43cm | | ✓ | 3X2G11 24W |
| PT.002C | 18cm | 110cm | 65cm | | ✓ | 4X2G11 36W |
| PT.003C | 18cm | 150cm | 86cm | | ✓ | 4X2G11 55W |
| PT.001.12C | 18cm | 70cm | 43cm | | ✓ | 2X2G11 24W DIMMABLE 1-10V |
| PT.002.12C | 18cm | 110cm | 65cm | | ✓ | 4X2G11 36W DIMMABLE 1-10V |
| PT.003.12C | 18cm | 150cm | 86cm | | ✓ | 4X2G11 55W DIMMABLE 1-10V |
| PT.001.13C | 18cm | 70cm | 43cm | | ✓ | 2X2G11 24W DIMMABLE-DALI |
| PT.002.13C | 18cm | 110cm | 65cm | | ✓ | 4X2G11 36W DIMMABLE-DALI |
| PT.003.13C | 18cm | 150cm | 86cm | | ✓ | 4X2G11 55W DIMMABLE-DALI |

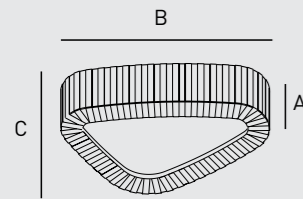

Ribboned ceiling lamp with methacrylate diffuser and magnetic mount. Only available in group-C ribbons.

Plafón encintado con difusor en metacrilato y sujeción por imanes. Disponible solo en cintas grupo C.

Deckenleuchte mit Band und Streuscheibe aus Methacrylat und Magnethalterung. Nur lieferbar mit Bändern der Gruppe C.

Plafonnier tissu plissé avec diffuseur en méthacrylate et fixation par aimants. Disponible uniquement avec des bandes du groupe C.



MATERIALS

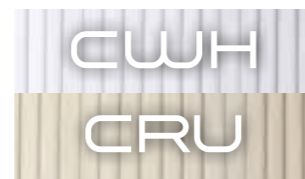

pleated fabrics
cinta plisada
plissiertes Band
ruban plissé

p 298



LODA

Andreu Carulla

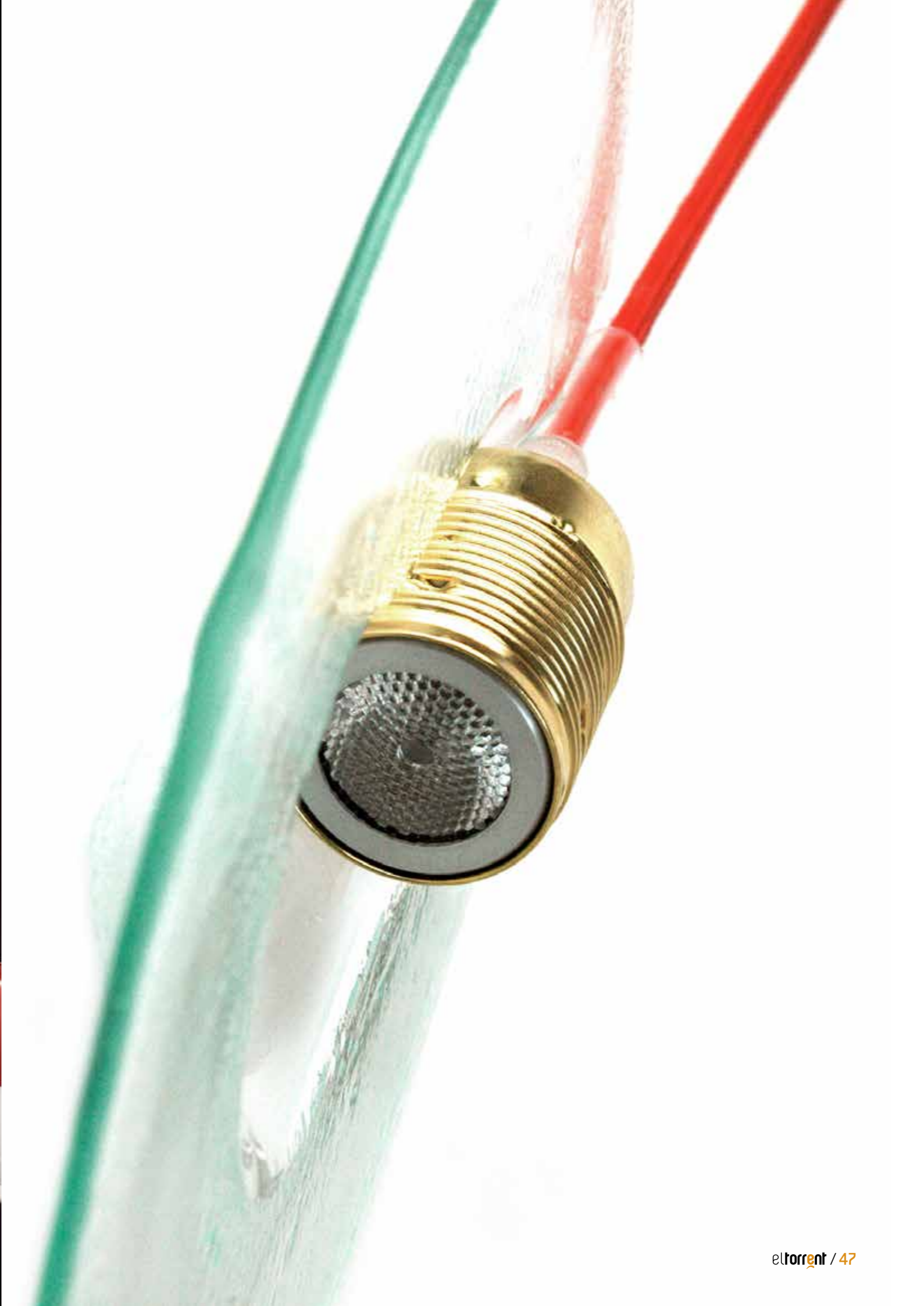

ODA

Andreu Carulla

CE IP20

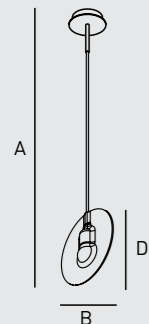

| ref | A | BØ | C | D | DIF | |
|--------|-------|------|---|------|-----|-----------|
| 00.001 | 100cm | 20cm | | 25cm | | A+ |

Crystal fusion pendant light with LED lighting, nickel plated body and red fabric cable.

Colgante de cristal fusión, iluminado por LED, con cuerpo niquelado y cable textil rojo.

Deckenleuchte aus verschmolzenem Glas, beleuchtet durch LED, Körper vernickelt und rotes Stoffkabel.

Lustre en verre fusion, éclairage par LED, corps nickelé et câble textile rouge.

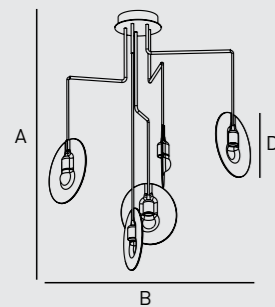

| ref | A | BØ | C | D | DIF | |
|--------|-------|------|---|------|-----|-----------|
| 00.002 | 100cm | 80cm | | 25cm | | A+ |

Crystal fusion pendant light with LED lighting, nickel plated body and red fabric cable.

Colgante de cristal fusión, iluminado por LED, con cuerpo niquelado y cable textil rojo.

Deckenleuchte aus verschmolzenem Glas, beleuchtet durch LED, Körper vernickelt und rotes Stoffkabel.

Lustre en verre fusion, éclairage par LED, corps nickelé et câble textile rouge.

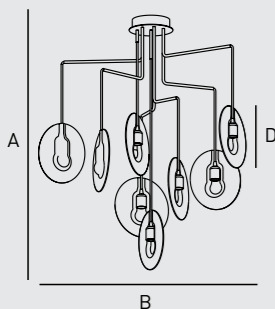

| ref | A | BØ | C | D | DIF | |
|--------|-------|------|---|------|-----|-----------|
| 00.003 | 100cm | 80cm | | 25cm | | A+ |

Crystal fusion pendant light with LED lighting, nickel plated body and red fabric cable.

Colgante de cristal fusión, iluminado por LED, con cuerpo niquelado y cable textil rojo.

Deckenleuchte aus verschmolzenem Glas, beleuchtet durch LED, Körper vernickelt und rotes Stoffkabel.

Lustre en verre fusion, éclairage par LED, corps nickelé et câble textile rouge.

PROJECT



Showroom
Sweden

p 61



EVA

Eloy Puig



EVA

Eloy Puig

CE IP20

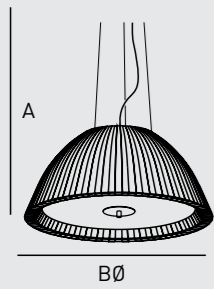

| ref | A | BØ | C | D | DIF | A | A+ | B |
|--------|-------|-------|---|------|-----|-----------------|---------------|--------------------|
| EV.419 | 130cm | 65cm | | 30cm | ✓ | 3xE-27 FLC 32W | 3xE27 LED 12W | 3xE-27 A60 ECO 42W |
| EV.420 | 130cm | 85cm | | 35cm | ✓ | 4xE-27 FLC 32W | 4xE27 LED 12W | 4xE-27 A60 ECO 42W |
| EV.421 | 130cm | 135cm | | 45cm | ✓ | 6 xE-27 FLC 32W | 6xE27 LED 12W | 6xE-27 A60 ECO 42W |

Pendant light with nickel plated ceiling rose and group C pleated dome.

Colgante con florón niquelado y cúpula encintada grupo C.

Deckenleuchte mit vernickeltem Baldachin und Kuppel foliert Gruppe C.

Lustre à fleuron nickelé et coupole enrubannée groupe C.

MATERIALS



pleated fabrics
cinta plisada
plissiertes Band
ruban plissé

p 298

PROJECT



Dan Design Center
Israel

p 61 p 238



Eloy Puig

SLIM

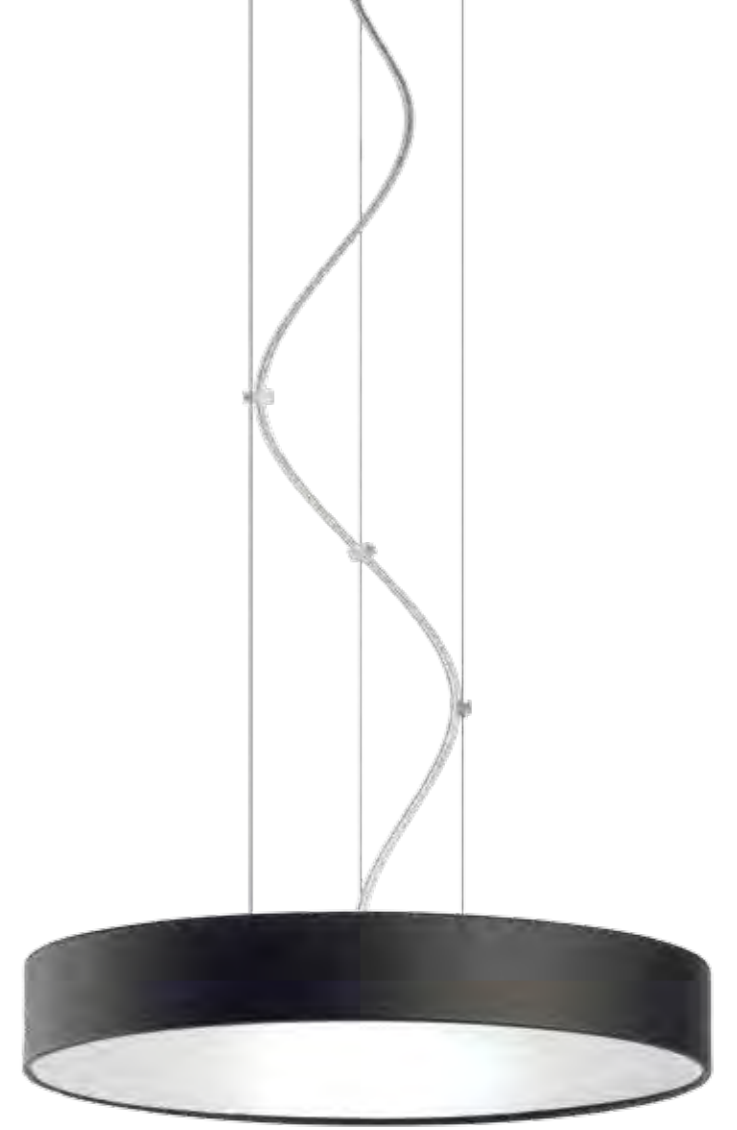

SLIM

Eloy Puig

CE   IP20

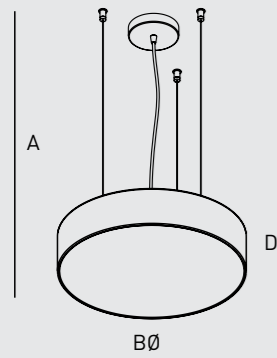

| ref | A | BØ | CØ | D | DIF | B  |
|------------|-------|-------|----|------|-----|---|
| SLC.010 | 130cm | 45cm | | 10cm | ✓ | 1xT5C 55w |
| SLC.011 | 130cm | 60cm | | 10cm | ✓ | 1xT5C 60w |
| SLC.012 | 130cm | 80cm | | 10cm | ✓ | 1xT5C 60w |
| SLC.013 | 130cm | 100cm | | 10cm | ✓ | 3xT5C 55w |
| SLC.014 | 130cm | 120cm | | 10cm | ✓ | 3xT5C 60w |
| SLC.010.12 | 130cm | 45cm | | 10cm | ✓ | 1xT5C 55w DIMMABLE 1-10V |
| SLC.011.12 | 130cm | 60cm | | 10cm | ✓ | 1xT5C 60w DIMMABLE 1-10V |
| SLC.012.12 | 130cm | 80cm | | 10cm | ✓ | 1xT5C 60w DIMMABLE 1-10V |
| SLC.013.12 | 130cm | 100cm | | 10cm | ✓ | 3xT5C 55w DIMMABLE 1-10V |
| SLC.014.12 | 130cm | 120cm | | 10cm | ✓ | 3xT5C 60w DIMMABLE 1-10V |
| SLC.010.13 | 130cm | 45cm | | 10cm | ✓ | 1xT5C 55w DIMMABLE-DALI |
| SLC.011.13 | 130cm | 60cm | | 10cm | ✓ | 1xT5C 60w DIMMABLE-DALI |
| SLC.012.13 | 130cm | 80cm | | 10cm | ✓ | 1xT5C 60w DIMMABLE-DALI |
| SLC.013.13 | 130cm | 100cm | | 10cm | ✓ | 3xT5C 55w DIMMABLE-DALI |
| SLC.014.13 | 130cm | 120cm | | 10cm | ✓ | 3xT5C 60w DIMMABLE-DALI |

Nickel pendant lamp and transparent cable with metallic upper diffuser. 10cm-high lampshade in any material.

Colgante en niquel y cable transparente, con difusor superior metálico. Pantalla de 10cm de altura en cualquier material

Hängelampe aus Nickel mit durchsichtigem Kabel, mit metallischem Diffusor oben. Schirm mit 10 cm Höhe, in allen Materialien erhältlich.

Suspension en nickel et câble transparent, diffuseur supérieur métallique. Abat-jour de 10 cm de haut, disponible dans tous les matériaux.

CABLES



Standard transparent electric cable. Possibility of choosing colour.
cable eléctrico estándar transparente. Posibilidad de escoger color.

Durchsichtiges Standard-Elektrokabel. Farbe nach Wahl.
câble électrique standard transparent. Possibilité de choisir la couleur.

p 304

MATERIALS



vinilo
vinyl
vinyl
vinyle

p 298



SLIM

Eloy Puig

CE    IP20



| ref | A | BØ | CØ | D | DIF | B  |
|-----------|---|-------|----|------|-----|---|
| SL.001 | | 45cm | | 10cm | ✓ | 1xT5C 55W |
| SL.003 | | 60cm | | 10cm | ✓ | 1xT5C 60W |
| SL.005 | | 80cm | | 10cm | ✓ | 1xT5C 60W |
| SL.007 | | 100cm | | 10cm | ✓ | 3xT5C 55W |
| SL.008 | | 120cm | | 10cm | ✓ | 3xT5C 60W |
| SL.001.12 | | 45cm | | 10cm | ✓ | 1xT5C 55W DIMMABLE 1-10V |
| SL.003.12 | | 60cm | | 10cm | ✓ | 1xT5C 60W DIMMABLE 1-10V |
| SL.005.12 | | 80cm | | 10cm | ✓ | 1xT5C 60W DIMMABLE 1-10V |
| SL.007.12 | | 100cm | | 10cm | ✓ | 3xT5C 55W DIMMABLE 1-10V |
| SL.008.12 | | 120cm | | 10cm | ✓ | 3xT5C 60W DIMMABLE 1-10V |
| SL.001.13 | | 45cm | | 10cm | ✓ | 1xT5C 55W DIMMABLE-DALI |
| SL.003.13 | | 60cm | | 10cm | ✓ | 1xT5C 60W DIMMABLE-DALI |
| SL.005.13 | | 80cm | | 10cm | ✓ | 1xT5C 60W DIMMABLE-DALI |
| SL.007.13 | | 100cm | | 10cm | ✓ | 3xT5C 55W DIMMABLE-DALI |
| SL.008.13 | | 120cm | | 10cm | ✓ | 3xT5C 60W DIMMABLE -DALI |

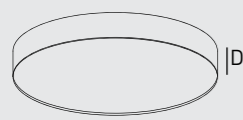

B

Extra-fl at ceiling lamp, available in any material. Magnetic mount.

Plafón extra plano, disponible en cualquier material. Sujeción por imanes.

Extrafl ache Deckenleuchte, in jedem Material lieferbar. Magnethalterung.

Plafonnier extra plat disponible dans n'importe quel matériau. Fixation par aimants.

MATERIALS



texplast
texplast
texplast
texplast

p 298



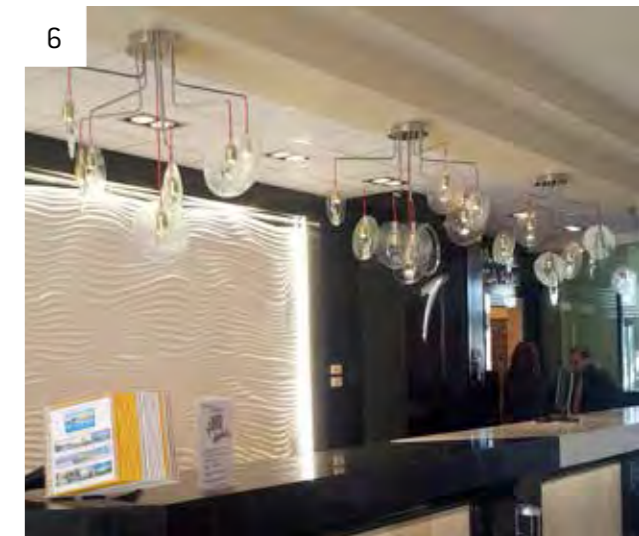

1
Restaurant One
Netherland

Modelo
ORGANIC

2
La boutique de Coiffeur
France

Modelo
ORGANIC

3
Cantina
Norway

Modelo
TUAREG / CITRIC

4
Sushi Restaurant
Spain

Modelo
EVA

5
Dan Design Center
Israel

Modelo
EVA

6
Hotel Zoraida
Spain

Modelo
ODA

7
Casa Decor Barcelona
Spain

Modelo
ODA



VER SAR TIL

Eloy Puig



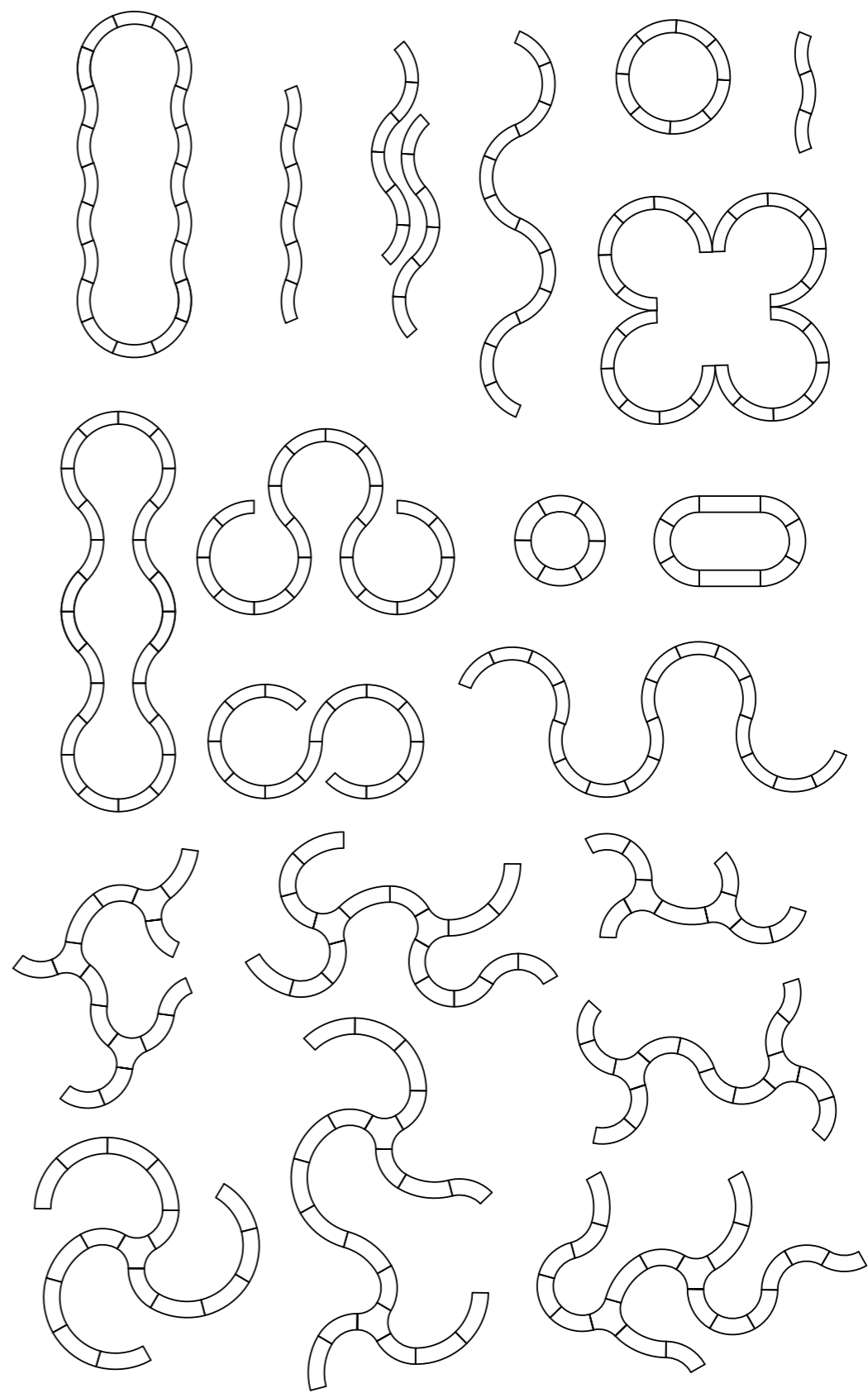

Different ways of combining shapes to give a particular space a distinctive lighting style.

Diferentes maneras de jugar con las formas para darle a un espacio un estilo luminoso singular.

Unterschiedliche Arten, mit den Formen zu spielen, um einem Raum einen besonderen Beleuchtungsstil zu verleihen.



De nombreuses façons de jouer avec les formes pour donner un style lumineux original à un espace.

VERSATIL

Eloy Puig

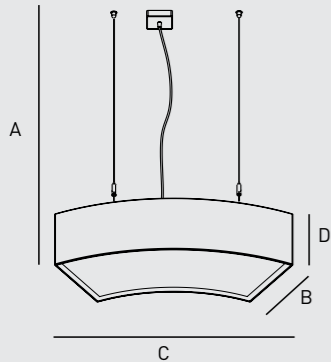
CE    IP20



| ref | A | B | C | D | DIF | A  | A+  | B  |
|--------|-------|------|-------|------|-----|---|--|---|
| VE.473 | 130cm | 25cm | 70cm | 17cm | ✓ | 2xE-27 FLC 25W | 2xE27 LED 12W | 2xE-27 A60 ECO 42W |
| VE.474 | 130cm | 25cm | 85cm | 17cm | ✓ | 4xE-27 FLC 25W | 4xE27 LED 12W | 4xE-27 A60 ECO 42W |
| VE.475 | 130cm | 35cm | 120cm | 25cm | ✓ | 4xE-27 FLC 25W | 4xE27 LED 12W | 4xE-27 A60 ECO 42W |

| ref | A | B | C | D | DIF | A  |
|-----------|-------|------|-------|------|-----|---|
| VE.474.11 | 130cm | 25cm | 85cm | 17cm | ✓ | 2xT5 28W |
| VE.474.12 | 130cm | 25cm | 85cm | 17cm | ✓ | 2xT5 28W DIMMABLE 1-10V |
| VE.475.11 | 130cm | 35cm | 85cm | 25cm | ✓ | 2xT5 39W |
| VE.475.12 | 130cm | 35cm | 120cm | 25cm | ✓ | 2xT5 39W DIMMABLE 1-10V |

Modules in 3 sizes that offer the possibility of creating circles of Ø 140, 225 or 310cm. Available in any material except:

BBQ / BNQ / DMN / DMW

Módulos en 3 tamaños que ofrecen la posibilidad de crear círculos de Ø 140, 225, 310cm. Disponible en cualquier material excepto:

BBQ / BNQ / DMN / DMW

Die Module sind in 3 Größen erhältlich und bieten die Möglichkeit, Kreise mit 140, 225 und 310 cm Durchmesser zu bilden. In allen Materialien erhältlich außer:

BBQ / BNQ / DMN / DMW

Modules en 3 tailles permettant de créer des cercles de Ø 140, 225, 310 cm. Disponible dans tous les matériaux sauf :

BBQ/BNQ/DMN/DMW

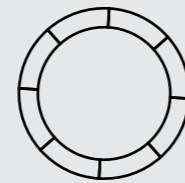
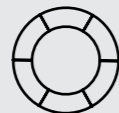

VE.473 Ø140cm

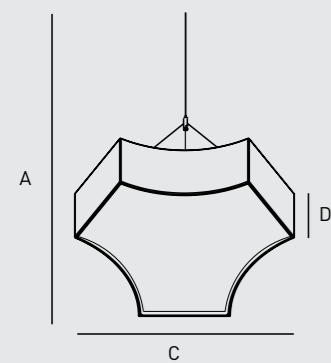

VE.474 Ø225cm

VE.475 Ø310cm



| ref | A | B | C | D | DIF | A  | A+  | B  |
|--------|-------|---|------|------|-----|---|--|---|
| VE.476 | 130cm | | 60cm | 17cm | ✓ | 3xE-27 FLC 25W | 3xE27 LED 12W | 3xE-27 A60 ECO 42W |

New shapes are now possible thanks to the VE.476 linking module, exclusively with the VE.473 and VE.474 models.

Ahora, son posibles nuevas formas con el módulo de unión VE.476, exclusivamente con los modelos VE.473 y VE.474.

Jetzt sind neue Formen möglich, mit dem Verbindungsmodul VE.476, ausschließlich mit dem Modellen VE.473 und VE.474.

Désormais, de nouvelles formes sont possibles grâce au module de liaison VE.476, uniquement avec les VE.473 et VE.474.



MATERIALS



pleated fabrics
cinta plisada
plissiertes Band
ruban plissé

p 298

PROJECT



Ziemeļu Varti
Latvia

p 138



Eloy Puig

GEMMA



GEMMA

Eloy Puig

CE IP20

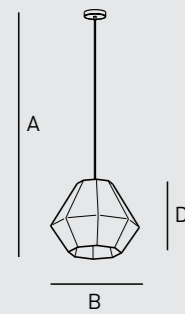

| ref | A | B | C | D | DIF | B | A+ |
|--------|-------|------|---|------|-----|----------------------|----------------|
| GM.001 | 130cm | 50cm | | 40cm | | 1xE27 PL E-GLOBE 32W | 1xE-27 LED 12W |

Nickel pendant lamp, red fabric cable. Acrylic elastic mesh lampshade.

Colgante en níquel, cable textil rojo. Pantalla en malla elástica acrílica.

Hängelampe aus Nickel, rotes Textil-Elektrokabel. Schirm aus elastischem Acrylmaschengewebe.

Suspension en nickel, câble textile rouge. Abat-jour en maille acrylique élastique.

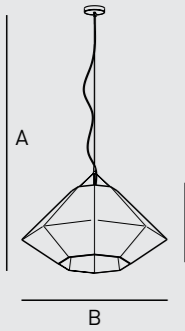

| ref | A | B | C | D | DIF | B | A+ |
|--------|-------|------|---|------|-----|----------------------|----------------|
| GM.002 | 150cm | 90cm | | 45cm | | 3xE27 PL E-GLOBE 32W | 3xE-27 LED 12W |

Nickel pendant lamp, red fabric cable. Acrylic elastic mesh lampshade.

Colgante en níquel, cable textil rojo. Pantalla en malla elástica acrílica.

Hängelampe aus Nickel, rotes Textil-Elektrokabel. Schirm aus elastischem Acrylmaschengewebe.

Suspension en nickel, câble textile rouge. Abat-jour en maille acrylique élastique.

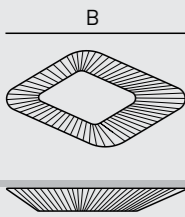

| ref | A | B | C | D | DIF | A+ |
|--------|---|------|------|-----|-----|------------------------------|
| GM.003 | | 25cm | 46cm | 5cm | ✓ | LED strip 14,5W 765Lm 6300°K |

Extra slim wall light, with 14.5W LED. Acrylic elastic mesh lampshade.

Aplique extra plano, con LED de 14,5w. pantalla en malla elástica acrílica.

Extraflache Wandlampe, mit LED 14,5W. Schirm aus elastischem Acrylmaschengewebe.

Applique extra-plate, à LED de 14,5 W. Abat-jour en maille acrylique élastique.

MATERIALS



Acrylic elastic band
Cinta malla elástica
Elastisches Maschengewebeband
Bande maille élastique

p 298



Eloy Puig

DUNA





DUNA

Eloy Puig

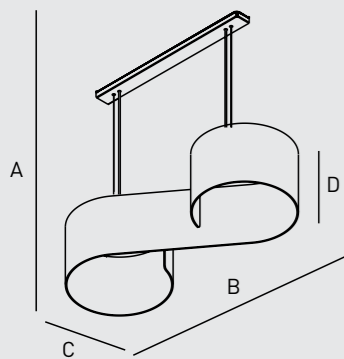
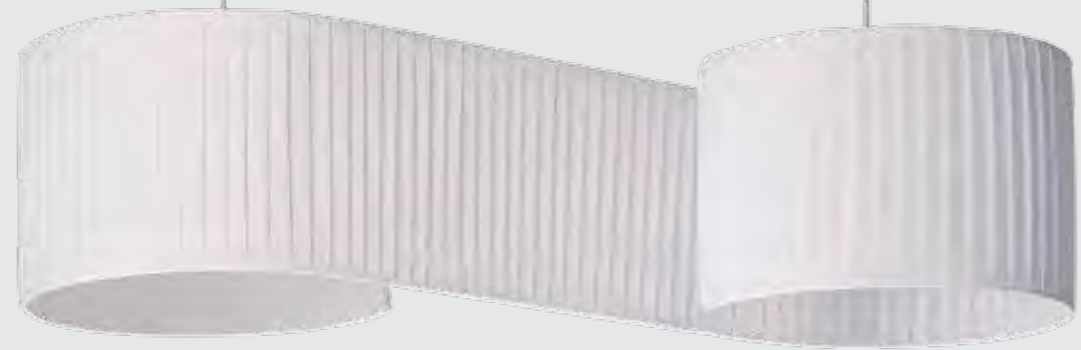
CE    IP20



| ref | A | B | C | D | DIF | A  | A+  | B  |
|--------|-------|-------|------|------|-----|---|--|---|
| DU.012 | 130cm | 80cm | 30cm | 20cm | | 2xE-27 FLC 32w | 2xE27 LED 12W | 2xE27 A60 ECO 42W |
| DU.013 | 130cm | 100cm | 35cm | 25cm | | 2xE-27 FLC 32w | 2xE27 LED 12W | 2xE27 A60 ECO 42W |
| DU.014 | 130cm | 120cm | 40cm | 30cm | | 2xE-27 FLC 32w | 2xE27 LED 12W | 2xE27 A60 ECO 42W |
| DU.015 | 130cm | 170cm | 60cm | 40cm | | 6xE-27 FLC 32w | 6xE27 LED 12W | 6xE27 A60 ECO 42W |

Pendant lamp with nickel plated ceiling rose and group C pleated lampshade.

Colgante con florón niquelado y pantalla encintada grupo C.

Lustre à fleuron nickelé et abat-jour enrubanné groupe C.

Deckenleuchte mit vernickeltem Baldachin und Schirm foliert Gruppe C.

MATERIALS



pleated fabrics
cinta plisada
plissiertes Band
ruban plissé

p 298

PROJECT



Casino Aspers
London

p 138

TRE BOU

Stimulo



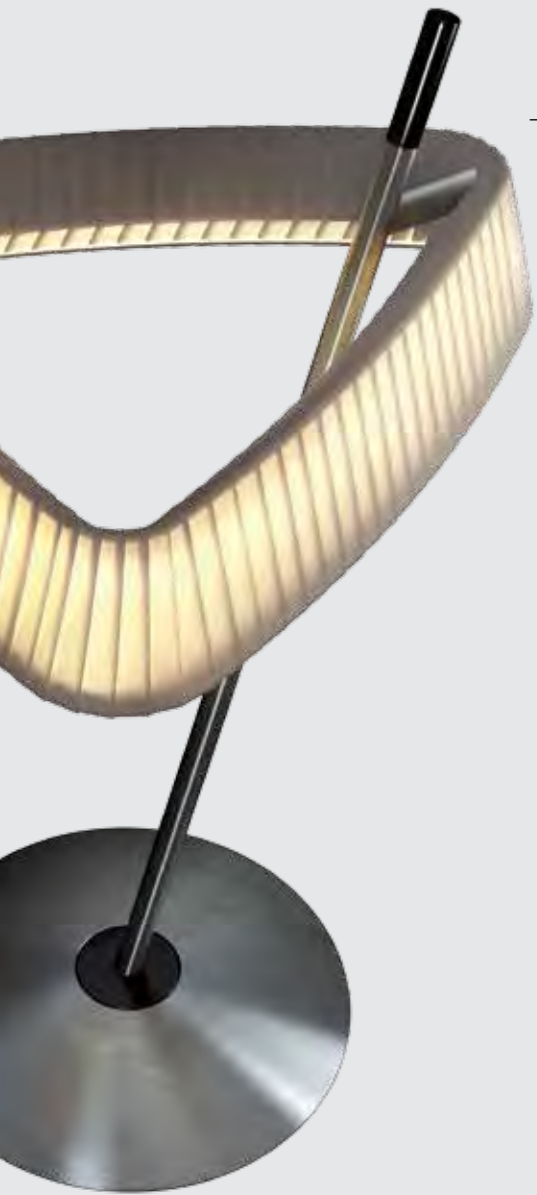

TREBOLA

Stimulo

CE □ ▽ IP20

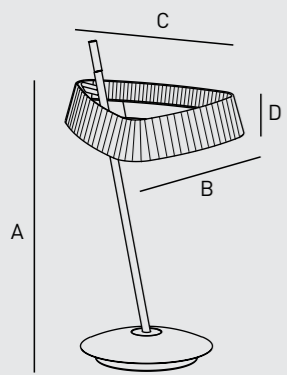

| ref | A | B | C | D | DIF | |
|--------|------|------|------|-----|-----|---------------------------------|
| TL.001 | 62cm | 33cm | 36cm | 8cm | | A+ LED Strip 30W 1630 Lm 6000°K |

Table lamp, LED lighting.
Nickel plated finish
and white pleated
lampshade.

Modelo de mesa con
iluminación por LED.
Acabado niquelado
y pantalla encintada
blanca

Modèle de table,
éclairage par LED.
Finition nickel et abat-
jour enrubanné blanc.

Tischmodell,
Beleuchtung durch LED.
Vernickeltes Finish,
Schirm weiß foliert.

MATERIALS



pleated fabrics
cinta plisada
plissiertes Band
ruban plissé
p 298

PROJECT



CasaDecor Barcelona
Spain
p 139





ELSA

Andreu Carulla



ELSA

Andreu Carulla

CE    IP20



Hollow lampshade
centre

Schirm in der
Mitte hohl

Centro de la
pantalla hueco

Centre de l'abat-jour
creux

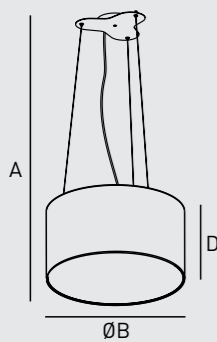

| ref | A | BØ | C | D | DIF | B |
|-----------|-------|------|---|------|-----|--------------------------|
| EL.001 | 130cm | 47cm | | 22cm | ✓ | 1xT5C 60w |
| EL.001.12 | 130cm | 47cm | | 22cm | ✓ | 1xT5C 60w DIMMABLE 1-10V |
| EL.001.13 | 130cm | 47cm | | 22cm | ✓ | 1xT5C 60w DIMMABLE-DALI |

Pendant lamp with truncated cone diffuser and chromed upper diffuser. Hidden interior lighting. Lampshade available in any material. Chromed ceiling rose.

Colgante con difusor troncocónico y tapa superior cromada. Iluminación oculta en el interior. Pantalla disponible en cualquier material. Florón cromado.

Deckenleuchte mit kegelstumpartigem Diffusor und verchromtem oberem Diffusor. Beleuchtung im Inneren versteckt. Schirm in jedem Material erhältlich. Verchromter Baldachin.

Lustre à diffuseur tronco-conique et diffuseur supérieur chromé. Éclairage dissimulé à l'intérieur. Abat-jour disponible dans n'importe quel matériel. Fleuron chromé.

MATERIALS



metallic vinyl
vinilo metalizado
Metallic Vinyl
vinyle Metallic

p 298





Eloy Puig

NEX



NEX

Eloy Puig

CE ⚡ F IP20

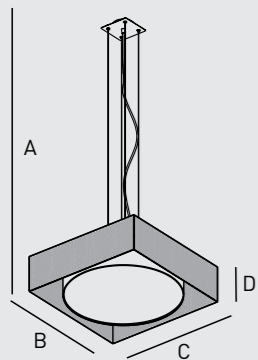

| ref | A | B | C | D | DIF | A | A+ | B |
|--------|-------|------|------|------|-----|----------------|---------------|--------------------|
| NX.001 | 130cm | 50cm | 50cm | 15cm | ✓ | 4xE-27 FLC 25W | 4xE27 LED 12W | 4xE-27 A60 ECO 42W |

Pendant lamp with double lampshade. Lower diffuser in acrylic. Nickel plated ceiling rose. Choice of plain materials for interior lampshade.

Colgante de doble pantalla. Difusor inferior de metacrilato. Florón niquelado. Pantalla interior a escoger entre materiales lisos.

Deckenleuchte mit zwei Schirmen. Unterer aus Metacrylat. Vernickelter Baldachin. Innerer Schirm aus glattem Material zu wählen.

Lustre à double abat-jour. Diffuseur inférieur en méthacrylate. Fleuron nickelé. Abat-jour intérieur au choix en matériel lisse.

MATERIALS



cotton + black mesh fabric
tejido algodón + rejilla negra
baumwollstoff + schwarzes Netz
tissu coton + résille noire

p 298





ElTorrent

SMOOTH





SMOOTH

ElTorrent

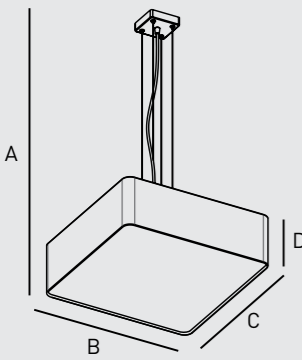
CE    IP20



| ref | A | B | C | D | DIF |  |  |  |
|--------|-------|------|------|------|-----|---|---|---|
| SM.001 | 130cm | 45cm | 45cm | 15cm | ✓ | 4xE-27 FLC 25W | 4xE27 LED 12W | 4xE-27 A60 ECO 42W |
| SM.002 | 130cm | 60cm | 60cm | 15cm | ✓ | 4xE-27 FLC 25W | 4xE27 LED 12W | 4xE-27 A60 ECO 42W |

Nickel plated pendant lamp with round-edged square lampshade, available in any material.

Colgante niquelado y pantalla cuadrada con canto romo, disponible en cualquier material.

Vernickelte Deckenleuchte, quadratischer Schirm mit abgestumpfter Kante, verfügbar in allen Materialien.

Lustre nickelé, abat-jour carré à tranche émoussée, disponible dans n'importe quel matériel.

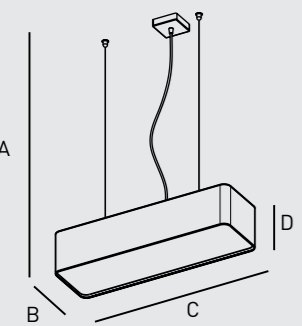

| ref | A | B | C | D | DIF |  |
|--------|-------|------|-------|------|-----|--|
| SM.003 | 130cm | 20cm | 65cm | 15cm | ✓ | 2xT5 28w |
| SM.004 | 130cm | 20cm | 120cm | 15cm | ✓ | 2xT5 39w |

Nickel plated pendant lamp with round-edged rectangle lampshade, available in any material.

Colgante niquelado y pantalla rectangular con canto romo, disponible en cualquier material.

Vernickelte Deckenleuchte, Bildschirmrechtecks Schirm mit abgestumpfter Kante, verfügbar in allen Materialien.

Lustre nickelé, abat-jour rectangle à tranche émoussée, disponible dans n'importe quel matériel.

MATERIALS



vinyl
vinilo
vinyl
vinyle

p 298



FLOCK

Eloy Puig





FLOCK

Eloy Puig

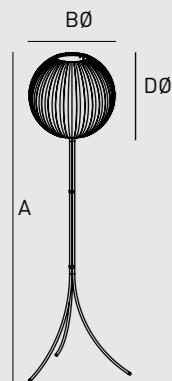
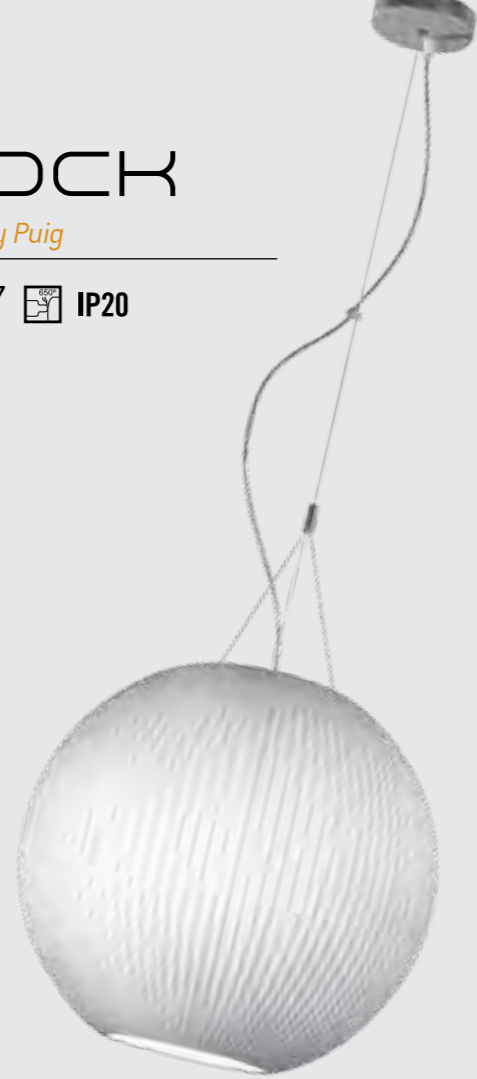

CE    IP20

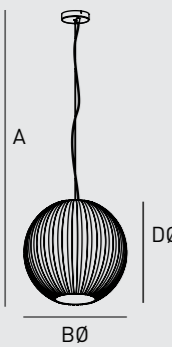

| ref | A | BØ | C | DØ | DIF | A  | B  |
|--------|-------|------|---|------|-----|--|---|
| FK.001 | 160cm | 45cm | | 45cm | | 1xE-27 FLC 65W | 1xE-27 A60 ECO 53W |

| | | | | |
|---|--|---|---|--|
|  | Floor lamp with chrome body and spherical group C pleated lampshade. | Modelo de pie con cuerpo cromado y pantalla esférica encintada grupo C. | Stehmodell, Körper verchromt, kugelförmiger Schirm, foliert Gruppe C. | Modèle sur pied, corps chromé, abat-jour sphérique enrubanné groupe C. |
|---|--|---|---|--|



| ref | A | BØ | C | DØ | DIF | A  | B  |
|--------|-------|------|---|------|-----|--|---|
| FK.002 | 130cm | 45cm | | 45cm | | 1xE-27 FLC 65W | 1xE-27 A60 ECO 53W |

| | | | | |
|---|--|---|--|---|
|  | Pendant lamp with chrome ceiling rose and spherical group C pleated lampshade. | Colgante con florón cromado, pantalla esférica encintada grupo C. | Deckenleuchte, verchromte Basis, kugelförmiger Schirm, foliert Gruppe C. | Lustre, fleuron chromé, abat-jour sphérique enrubanné groupe C. |
|---|--|---|--|---|

MATERIALS



pleated fabrics
cinta plisada
plissiertes Band
ruban plissé
p 298

PROJECT

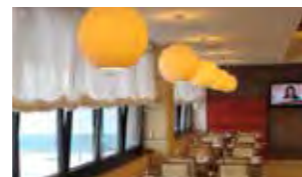

Hotel Bristol
Sarajevo
p 138





Eloy Puig

CITRIC

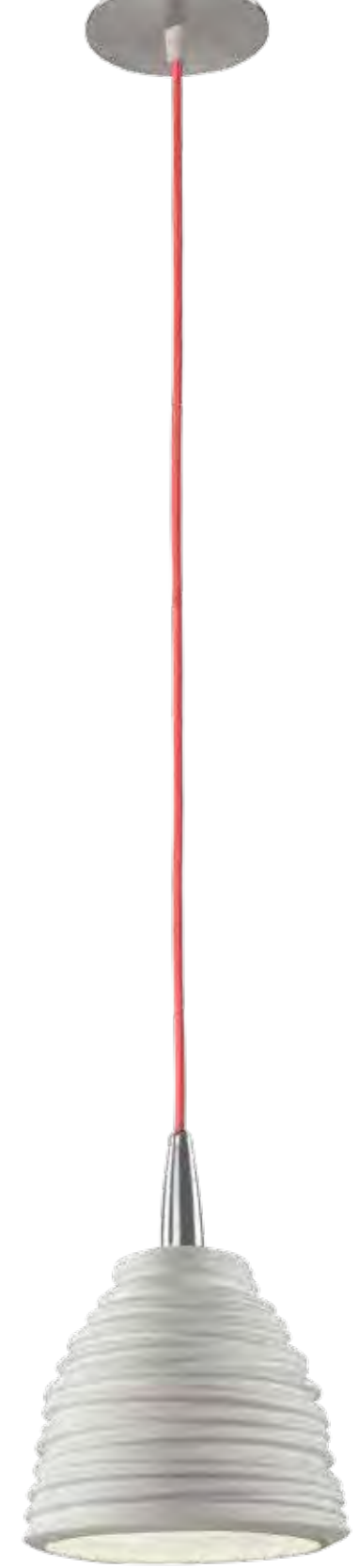



CITRIC

Eloy Puig

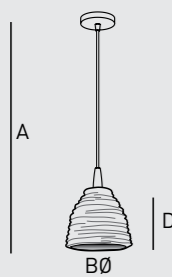
CE    IP20



| ref | A | BØ | CØ | D | DIF | A  | A+  |
|--------|-------|------|----|------|-----|---|--|
| CT.001 | 130cm | 17cm | | 14cm | | 1xE-27 FLC 25W | 1xE27 LED 12W |



Natural-colour porcelain wall fixture with satin nickel bracket and red fabric cable.

Colgante en porcelana en color natural con florón en níquel satinado y cable textil rojo.

Hängeleuchte aus naturfarbenem Porzellan mit satiniert vernickelter Wandhalterung und Rosette und rotem Stoffkabel.

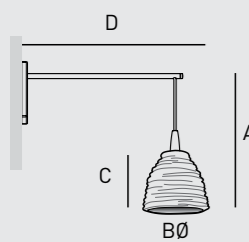
Suspensión en porcelaine de couleur naturelle avec support en nickel satiné et câble textile rouge.



| ref | A | BØ | C | D | DIF | A  | A+  |
|--------|------|------|------|------|-----|--|--|
| CT.002 | 37cm | 17cm | 15cm | 58cm | | 1xE-27 FLC 25W | 1xE27 LED 12W |

Natural-colour porcelain wall fixture with satin nickel bracket and red fabric cable.

Aplique en porcelana en color natural con soporte níquel satinado y cable textil rojo.

Wandleuchte aus naturfarbenem Porzellan mit satiniert vernickelter Wandhalterung und Rosette und rotem Stoffkabel.

Aplique en porcelaine de couleur naturelle avec support en nickel satiné et câble textile rouge.

PROJECT

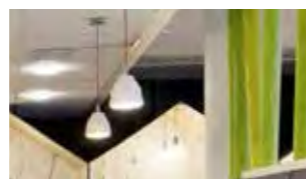

Cantina
Norway

p 138



Eloy Puig

BRUNZ



BRUNZ

Eloy Puig

CE    IP20

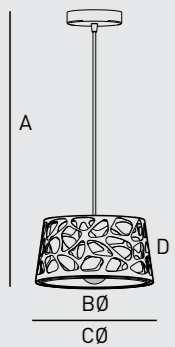

| ref | A | BØ | CØ | D | DIF | |
|---------------|-------|------|------|------|-----|---|
| BR.001 | 130cm | 25cm | 22cm | 14cm | |  1XE-27 MIRROR 15W BULB INCLUDED |

Pendant lamp with black canopy and fabric cable. Die-cut triple shade in black and white and metallic inner shade, with E-27 mirror bulb included.

Colgante con florón negro y cable textil. Triple pantalla troquelada en blanco y negro y pantalla interior metalizada, con bombilla E-27 espejo incluida.

Hängeleuchte mit schwarz Rosette und Stoffkabel. Gestanzter, dreifacher Lampenschirm in Weiß und Schwarz, Innenschirm metallisiert, einschließlich Spiegellampe E-27.

Suspensión avec fl euron noir et câble textile. Abat-jour triple embouti noir et blanc et abat-jour intérieur métallisé, avec ampoule E-27 miroir incluse.





Eloy Puig

SONORA



SONORA

Eloy Puig

CE    IP20

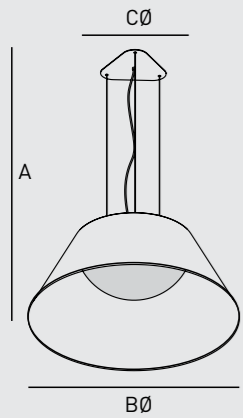

| ref | A | BØ | CØ | D | DIF | |
|------------------|-------|------|------|------|-----|--------------------------|
| S0.001 | 150cm | 80cm | 45cm | 30cm | ✓ | 1xT5C 60w |
| S0.001.12 | 150cm | 80cm | 30cm | 30cm | ✓ | 1xT5C 60w DIMMABLE 1-10v |
| S0.001.13 | 150cm | 80cm | 30cm | 30cm | ✓ | 1xT5C 60w DIMMABLE-DALI |

Pendant lamp with black textile exterior and engraved vinyl interior. Upper diffuser in aluminium, semi-spherical lower diffuser in acrylic. Chromed ceiling rose with orange fabric cable.

Colgante de textil negro exterior y vinilo grabado interior. Difusor superior metálico e inferior semiesférico de metacrilato. Florón cromado y cable textil naranja.

Deckenleuchte aus schwarzem Stoff außen und geprägtem Vinyl innen. Oberer Diffusor aus poliertem Aluminium, unterer halbkugelförmig aus Metacrylat. Verchromter Baldachin, oranges Stoffkabel.

Lustre en textile noir extérieur et vinyle gravé intérieur. Diffuseur en aluminium, inférieur semi-sphérique en méthacrylate. Fleuron chromé câble textile orange.

MATERIALS



cotton + metallic vinyl
tejido algodón + vinilo metalizado
baumwollstoff + Metallic Vinyl
tissu coton + vinyle Metallic

p 298





KOO RAL BUN

Eloy Puig





KOORALBYN

Eloy Puig

CE V IP20

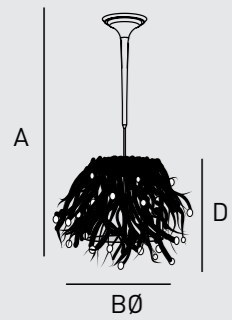

| ref | A | BØ | C | D | DIF | A | A+ | B |
|--------|-------|------|---|------|-----|----------------|---------------|--------------------|
| KR.425 | 130cm | 40cm | | 40cm | | 1xE-27 FLC 25W | 1xE27 LED 12W | 1xE-27 A60 ECO 42W |
| KR.426 | 130cm | 60cm | | 50cm | | 1xE-27 FLC 32w | 1xE27 LED 12W | 1xE-27 A60 ECO 42W |



Chromed and black graphite pendant lamp with black chenille and Swarovski crystal lampshade.

Colgante cromado y grafito negro; pantalla de chenilla negra y cristal Swarovski.

Deckenleuchte verchromt und schwarzer Grafit, Schirm aus schwarzer Chenille und Swarovski Kristall.

Lustre chromé et graphite noir, abat-jour en chenille noire et verre Swarovski.

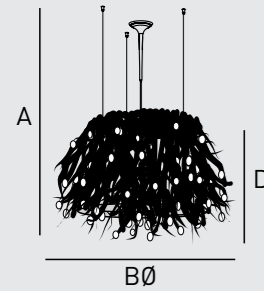

| ref | A | BØ | C | D | DIF | A | A+ | B |
|--------|-------|------|---|------|-----|----------------|---------------|--------------------|
| KR.427 | 130cm | 80cm | | 60cm | | 3xE-27 FLC 25W | 3xE27 LED 12W | 3xE-27 A60 ECO 42W |



Chromed and black graphite pendant lamp with black chenille and Swarovski crystal lampshade.

Colgante cromado y grafito negro; pantalla de chenilla negra y cristal Swarovski.

Deckenleuchte verchromt und schwarzer Grafit, Schirm aus schwarzer Chenille und Swarovski Kristall.

Lustre chromé et graphite noir, abat-jour en chenille noire et verre Swarovski.

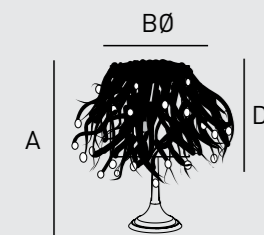

| ref | A | BØ | C | D | DIF | A | A+ | B |
|--------|------|------|---|------|-----|----------------|---------------|--------------------|
| KR.424 | 48cm | 40cm | | 40cm | | 1xE-27 FLC 25W | 1xE27 LED 12W | 1xE-27 A60 ECO 42W |



Table lamp with a chromed and black graphite base and a black chenille and Swarovski crystal lampshade.

Modelo de sobremesa con base cromada y grafito negro; pantalla de chenilla negra y cristal Swarovski.

Tischlampe, Basis verchromt und schwarzer Grafit, Schirm aus schwarzer Chenille und Swarovski Kristall.

Modèle de table, base chromée et graphite noir, abat-jour en chenille noire et verre Swarovski.



CITY





CITY

Eloy Puig

CE IP20

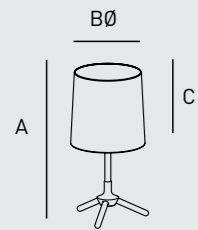

| ref | ref | ref | A | BØ | C | DIF | A | A+ | B |
|--------|--------|--------|------|------|------|-----|----------------|----------------|--------------------|
| CY.001 | CY.011 | CY.021 | 43cm | 20cm | 20cm | | 1xE-27 FLC 21W | 1xE27 LED 12 W | 1xE-27 A60 ECO 42W |

Collapsible table lamp in nickel, black or white. Lampshade available in any material. Modelo de mesa desmontable en níquel, negro o blanco. Pantalla disponible en cualquier material. Tischlampe, zerlegbar, aus Nickel, schwarz oder weiß. Schirm in allen Materialien erhältlich. Modèle à poser démontable, en nickel, noir ou blanc. Abat-jour disponible dans tous les matériaux.

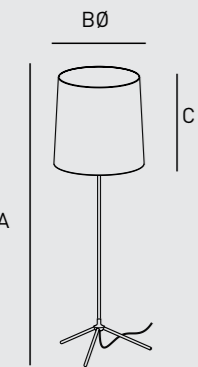

| ref | ref | ref | A | BØ | C | DIF | A | A+ | B |
|--------|--------|--------|-------|------|------|-----|----------------|---------------|--------------------|
| CY.002 | CY.012 | CY.022 | 165cm | 50cm | 50cm | | 1xE-27 FLC 25W | 1xE27 LED 12W | 1xE-27 A60 ECO 42W |

Collapsible floor lamp in nickel, black or white. Lampshade available in any material. Modelo de pie desmontable en níquel, negro o blanco. Pantalla disponible en cualquier material. Stehlampe, zerlegbar, aus Nickel, schwarz oder weiß. Schirm in allen Materialien erhältlich. Lampadaire démontable en nickel, noir ou blanc. Abat-jour disponible dans tous les matériaux.

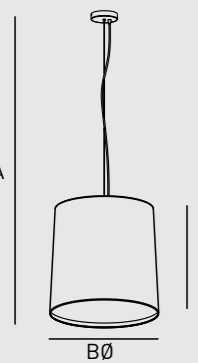

| ref | ref | ref | A | BØ | C | DIF | A | A+ | B |
|--------|--------|--------|-------|------|------|-----|----------------|---------------|--------------------|
| CY.003 | CY.013 | CY.023 | 150cm | 50cm | 50cm | | 1xE-27 FLC 25W | 1xE27 LED 12W | 1xE-27 A60 ECO 42W |

Pendant lamp in nickel, black or white. Lampshade available in any material. Without diffuser. Colgante en níquel, negro o blanco. Pantalla disponible en cualquier material. Sin difusor. Hängelampe aus Nickel, schwarz oder weiß. Schirm in allen Materialien erhältlich. Ohne Streuscheibe. Suspension en nickel, noir ou blanc. Abat-jour disponible dans tous les matériaux. Sans diffuseur.



MATERIALS



fabric
tejido
stoff
tissu
p 298

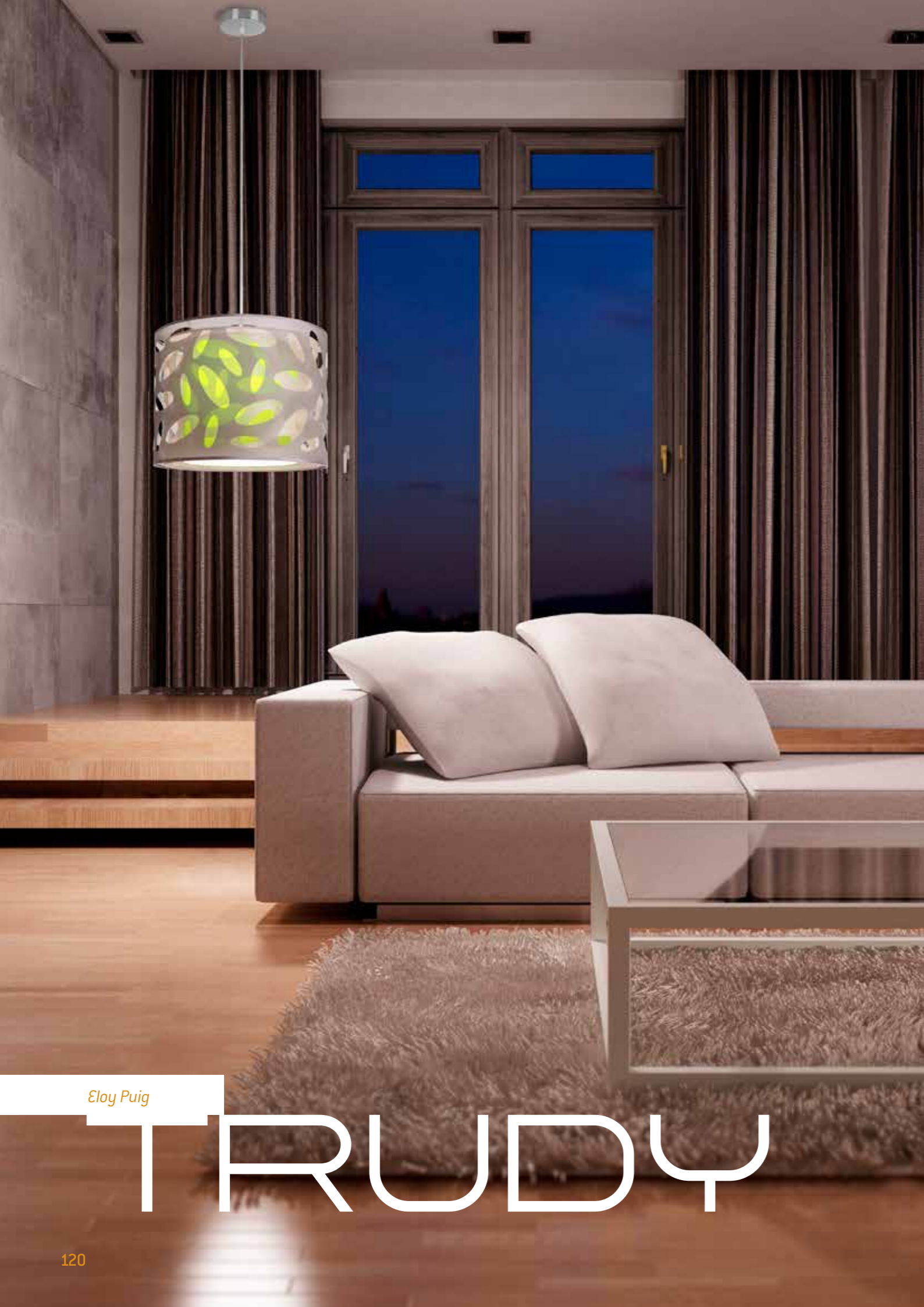

Eloy Puig

TRUDY









TRUDY

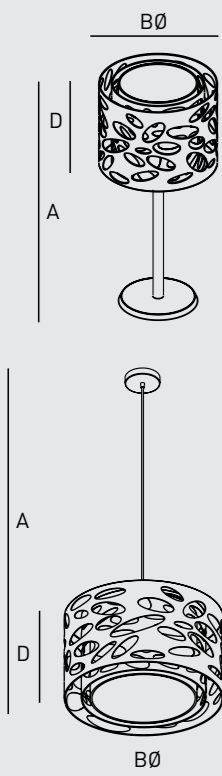

Eloy Puig

CE   IP20



| ref | A | BØ | C | D | DIF | A  | A+  | B  |
|---------------|-------|------|---|------|-----|---|--|---|
| TD.415 | 80cm | 45cm | | 35cm | | 1xE-27 FLC 25W | 1xE27 LED 12W | 1xE-27 A60 ECO 42W |
| TD.416 | 170cm | 45cm | | 35cm | | 1xE-27 FLC 25W | 1xE27 LED 12W | 1xE-27 A60 ECO 42W |

 Floor lamp with nickel base, triple die-cut lampshade with choice of plain interior.
 Modelo con base niquelada, triple pantalla troquelada e interior liso a escoger.
 Modell, vernickelte Basis, geprägter dreifacher Schirm, innen glatt auswählbar.
 Modèle à base nickelée, triple abat-jour imprimé, intérieur uni au choix.

| ref | A | BØ | C | D | DIF | A  | A+  | B  |
|---------------|-------|------|---|------|-----|---|--|---|
| TD.417 | 130cm | 45cm | | 35cm | | 1xE-27 FLC 25W | 1xE27 LED 12W | 1xE-27 A60 ECO 42W |
| TD.418 | 130cm | 60cm | | 35cm | | 1xE-27 FLC 25W | 1xE27 LED 12W | 1xE-27 A60 ECO 42W |

 Pendant lamp with nickel base, triple die-cut lampshade with choice of plain interior.
 Colgante niquelado con triple pantalla troquelada e interior liso a escoger.
 Vernickelte Deckenleuchte, geprägter dreifacher Schirm, innen glatt auswählbar.
 Lustre nickelé, triple abat-jour imprimé, intérieur uni au choix.

MATERIALS



organzie
organza
organza
organza
p 298

PROJECT



Sushi Sun Restaurant
Russia
p139

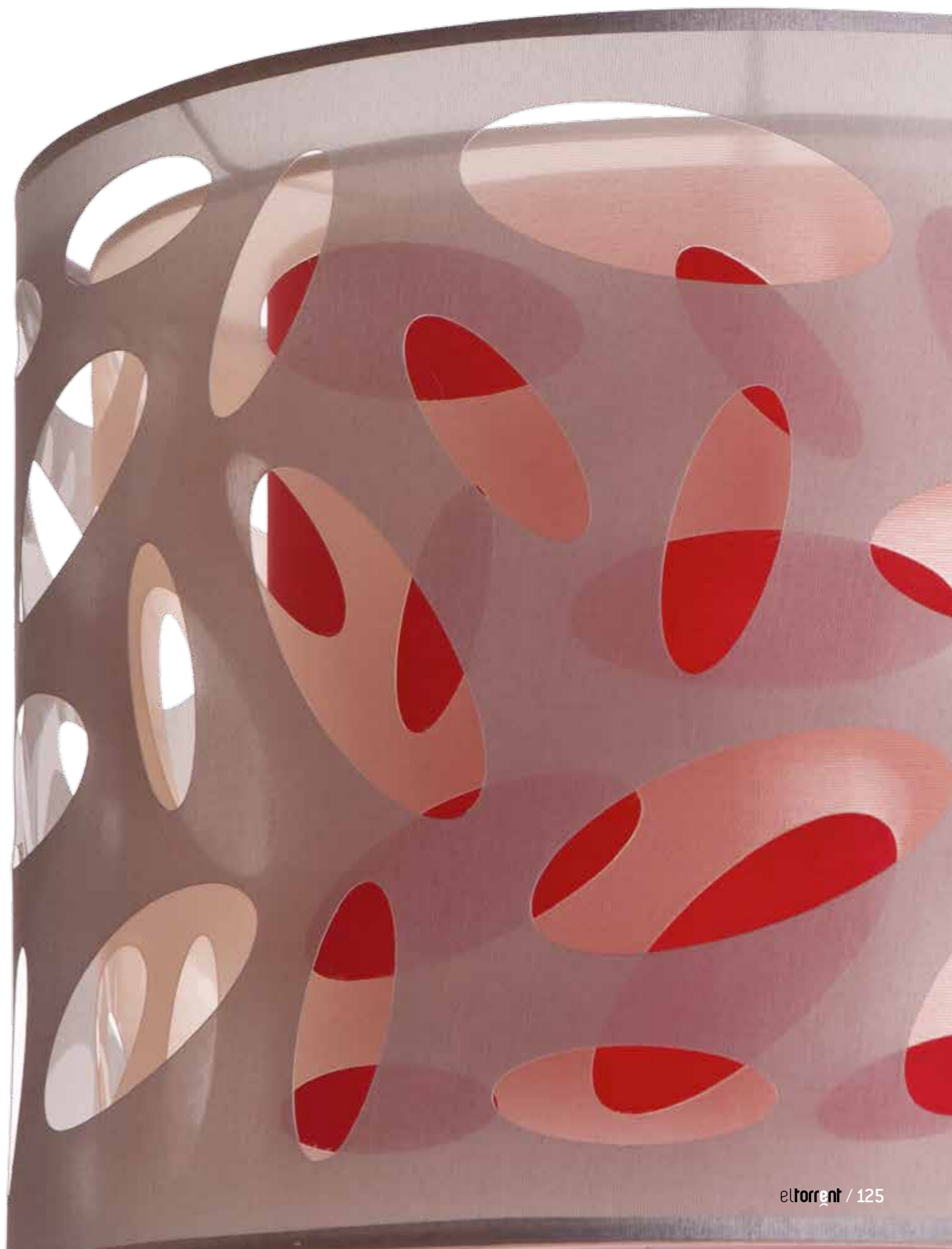



Eloy Puig

NONA





NONA

Eloy Puig

CE V F IP20

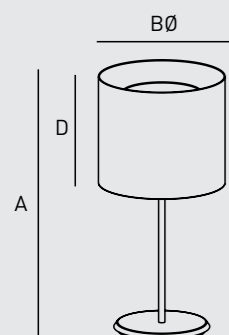

| ref | A | BØ | C | D | DIF | A | A+ | B |
|--------|-------|------|---|------|-----|----------------|---------------|--------------------|
| NN.450 | 40cm | 20cm | | 17cm | | 1xE-27 FLC 25W | 1xE27 LED 12W | 1xE-27 A60 ECO 42W |
| NN.451 | 75cm | 40cm | | 27cm | | 1xE-27 FLC 25W | 1xE27 LED 12W | 1xE-27 A60 ECO 42W |
| NN.452 | 165cm | 40cm | | 27cm | | 1xE-27 FLC 25W | 1xE27 LED 12W | 1xE-27 A60 ECO 42W |

□ Floor and table lamp with nickel plated base, double lampshade with embroidered organdie exterior and white interior. Modelo de mesa y pie con base niquelada, doble pantalla, exterior de organza bordada e interior blanco. Modell, vernickelte Basis, doppelter Schirm, außen bestickter Organza, innen weiß. Modèle à base nickelée, double abat-jour, extérieur organza brodé intérieur blanc.

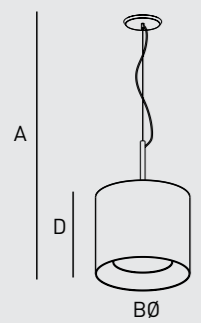

| ref | A | BØ | C | D | DIF | A | A+ | B |
|--------|-------|------|---|------|-----|----------------|---------------|--------------------|
| NN.455 | 130cm | 40cm | | 27cm | | 1xE-27 FLC 25W | 1xE27 LED 12W | 1xE-27 A60 ECO 42W |

⊕ Pendant lamp with nickel plated base, double lampshade with embroidered organdie exterior and white interior. Colgante niquelado, doble pantalla, exterior de organza bordada e interior blanco. Deckenleuchte vernickelt, doppelter Schirm, außen bestickter Organza, innen weiß. Lustre nickelé, double abat-jour, extérieur organza brodé intérieur blanc.

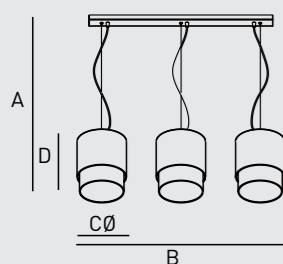

| ref | A | B | CØ | D | DIF | A | A+ | B |
|--------|-------|------|------|------|-----|----------------|--------------|--------------------|
| NN.456 | 130cm | 85cm | 20cm | 20cm | | 3xE-27 FLC 21W | 3xE27 LED 9W | 1xE-27 A60 ECO 42W |

⊕ Pendant lamp with nickel plated base, double lampshade with embroidered organdie exterior and white interior. Colgante niquelado, doble pantalla, exterior de organza bordada e interior blanco. Deckenleuchte vernickelt, doppelter Schirm, außen bestickter Organza, innen weiß. Lustre nickelé, double abat-jour, extérieur organza brodé intérieur blanc.

MATERIALS



embroidered organdie
organza bordada
bestickter Organza
organza brodé
p 298

PROJECT



CasaDecor Barcelona
Spain
p 139



Eloy Puig

BER TA







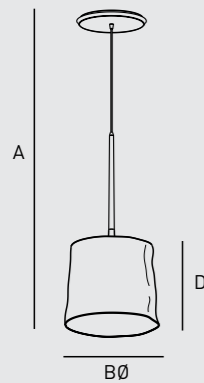

BERTA

Eloy Puig

CE   IP20



| ref | A | BØ | C | D | DIF | A  | A+  | B  |
|--------|-------|------|---|------|-----|---|--|---|
| BE.485 | 130cm | 40cm | | 35cm | | 1xE-27 FLC 25W | 1xE27 LED 12W | 1xE-27 A60 ECO 42W |
| BE.497 | 130cm | 20cm | | 20cm | | 1xE-27 FLC 25W | 1xE27 LED 12W | 1xE-27 A60 ECO 42W |







Pendant lamp with chromed conical body and imitation chrome polyester lampshade.

Colgante de cuerpo cónico cromado y pantalla de poliéster imitación cromo.

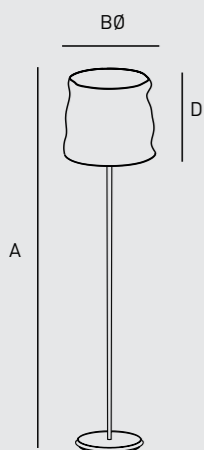
Deckenleuchte mit kegelförmigem, verchromtem Körper, Schirm aus Polyester-Chromimitation.

Lustre à corps conique chromé, abat-jour polyester imitation chrome.



| ref | A | BØ | C | D | DIF | A  | A+  | B  |
|--------|-------|------|---|------|-----|---|--|---|
| BE.484 | 170cm | 40cm | | 35cm | | 1xE-27 FLC 25W | 1xE27 LED 12W | 1xE-27 A60 ECO 42W |



Floor lamp with chromed conical body and imitation chrome polyester lampshade.

Modelo de cuerpo cónico cromado y pantalla de poliéster imitación cromo.

Modell mit kegelförmigem, verchromtem Körper, Schirm aus Polyester-Chromimitation.

Modèle à corps conique chromé, abat-jour polyester imitation chrome.

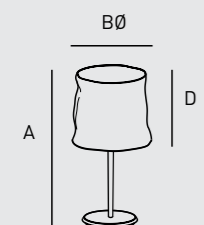



| ref | A | BØ | C | D | DIF | A  | A+  | B  |
|--------|------|------|---|------|-----|---|--|---|
| BE.482 | 48cm | 20cm | | 20cm | | 1xE-27 FLC 25W | 1xE27 LED 12W | 1xE-27 P45 ECO 42W |
| BE.483 | 80cm | 40cm | | 35cm | | 1xE-27 FLC 25W | 1xE27 LED 12W | 1xE-27 A60 ECO 42W |



Table lamp with chromed conical body and imitation chrome polyester lampshade.

Modelo de cuerpo cónico cromado y pantalla de poliéster imitación cromo.

Modell mit kegelförmigem, verchromtem Körper, Schirm aus Polyester-Chromimitation.

Modèle à corps conique chromé, abat-jour polyester imitation chrome.

MATERIALS



Imitation chrome polyester.
Poliéster imitación cromo.
Polyester Chromimitation
Polyester imitation chrome.

PROJECT



Sushi Yama Söderhallarna
Sweden

p 138



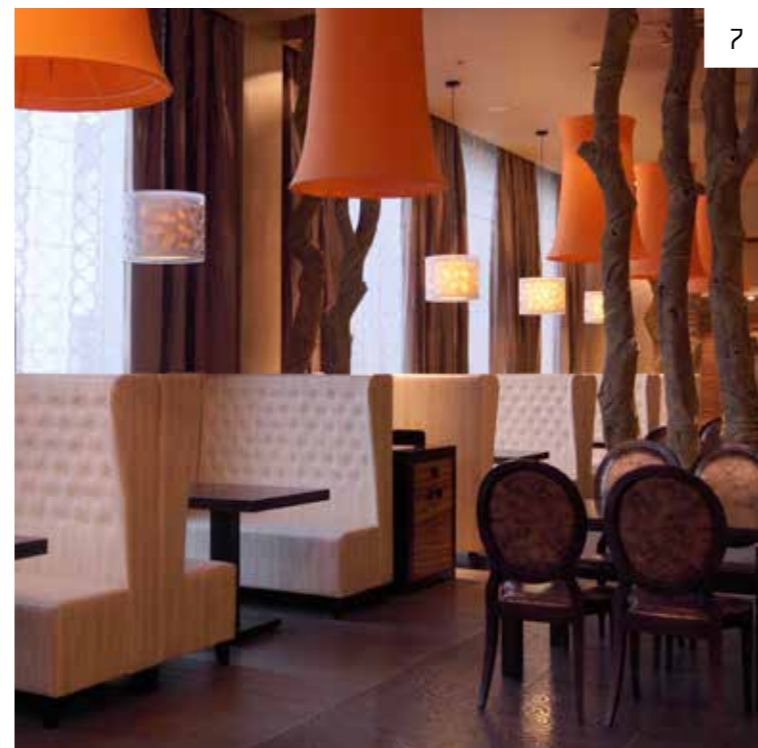
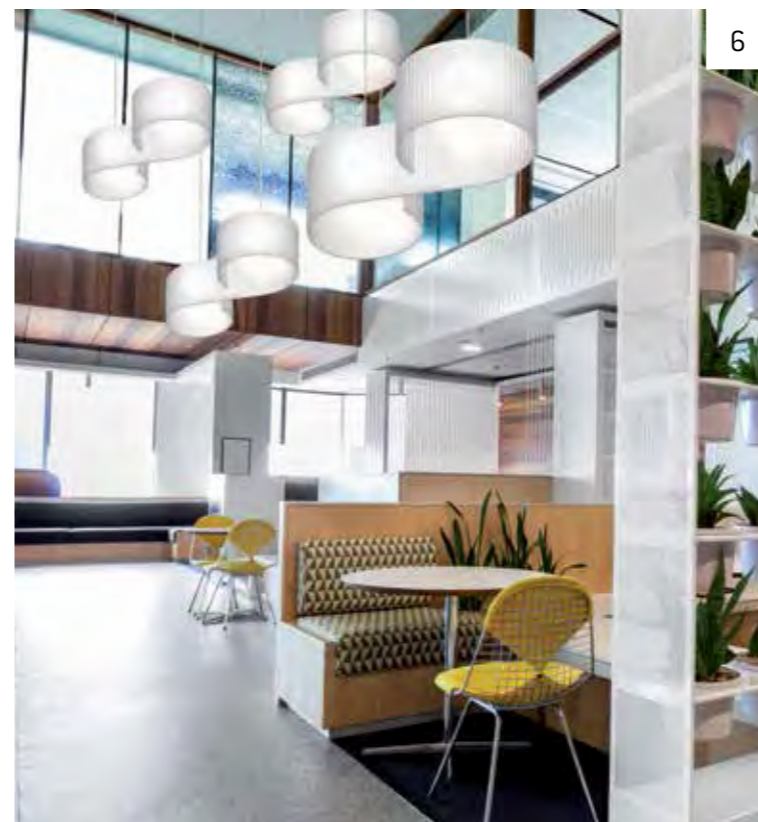

1
Hotel Bristol
Sarajevo

Modelo
FLOCK

2
Cantina
Norway

Modelo
TUAREG/CITRIC

3
Sushi Yama Söderhallarna
Sweden

Modelo
BERTA

4
Casino Aspens
London

Modelo
DUNA

5
Ziemelu Varti
Latvia

Modelo
VERSATIL

6
Private Offices
Spain

Modelo
DUNA

7
Sushi Sun Restaurant
Russia

Modelo
TRUDY/SPECIAL

8
CasaDecor Barcelona
Spain

Modelo
TREBOLA

9
CasaDecor Barcelona
Spain

Modelo
NONA

Eloy Puig

BRAN

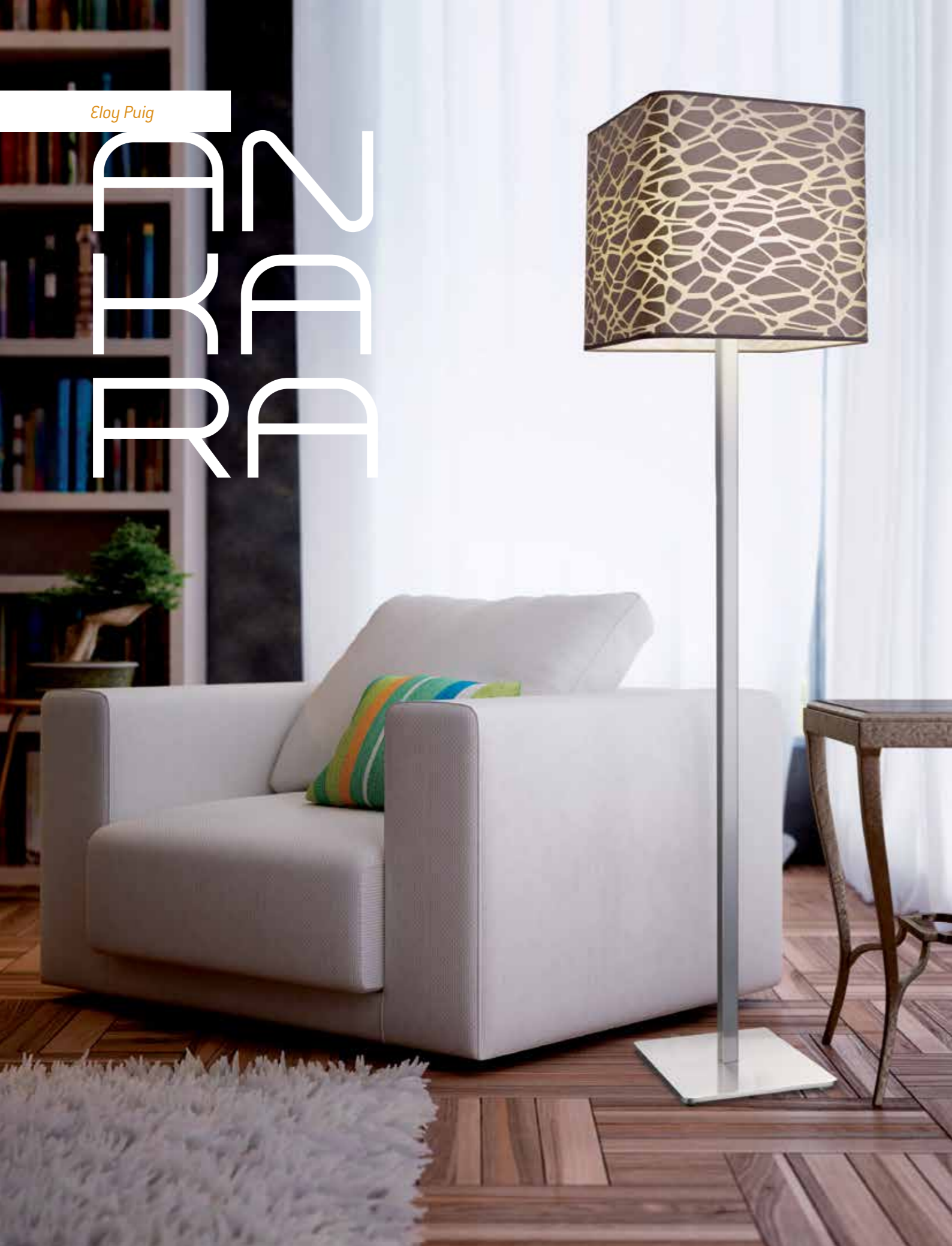



ANKARA

Eloy Puig

CE V IP20

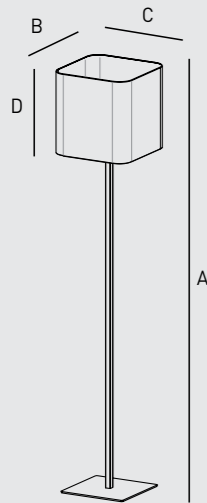

| ref | A | B | C | D | DIF | A | A+ | B |
|---------------|-------|------|------|------|-----|----------------|---------------|--------------------|
| AK.502 | 165cm | 30cm | 30cm | 30cm | | 1xE-27 FLC 25W | 1xE27 LED 12W | 1xE-27 A60 ECO 42W |

Floor lamp with nickel plated base, lampshade available in any material. Modelo con base niquelada y pantalla disponible en cualquier material. Modell, vernickelte Basis, Schirm in allen Materialien verfügbar. Modèle à base nickelée, abat-jour disponible dans n'importe quel matériel.

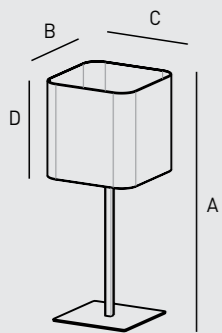

| ref | A | B | C | D | DIF | A | A+ | B |
|---------------|------|------|------|------|-----|----------------|---------------|--------------------|
| AK.500 | 40cm | 18cm | 18cm | 18cm | | 1xE-27 FLC21W | 1xE27 LED 5W | 1xE-27 P45 ECO 42W |
| AK.501 | 75cm | 30cm | 30cm | 30cm | | 1xE-27 FLC 25W | 1xE27 LED 12W | 1xE-27 A60 ECO 42W |

Table lamp with nickel plated base, lampshade available in any material. Modelo con base niquelada y pantalla disponible en cualquier material. Modell, vernickelte Basis, Schirm in allen Materialien verfügbar. Modèle à base nickelée, abat-jour disponible dans n'importe quel matériel.

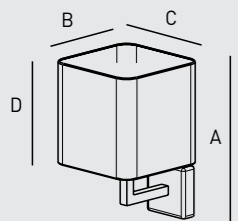

| ref | A | B | C | D | DIF | A | A+ | B |
|---------------|------|------|------|------|-----|----------------|--------------|-------------------|
| AK.503 | 32cm | 18cm | 18cm | 18cm | | 1xE-27 FLC 21W | 1xE27 LED 5W | 1xE-27P45 ECO 42W |

Nickel plated wall lamp, lampshade available in any material. Aplique niquelado y pantalla disponible en cualquier material. Wandlampe vernickelt, Schirm in allen Materialien verfügbar. Applique nickelés, abat-jour disponible dans n'importe quel matériel.

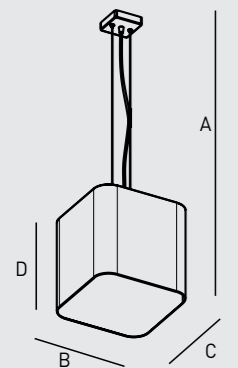

| ref | A | B | C | D | DIF | A | A+ | B |
|---------------|-------|------|------|------|-----|----------------|---------------|--------------------|
| AK.504 | 130cm | 30cm | 30cm | 40cm | | 1xE-27 FLC 25W | 1xE27 LED 12W | 1xE-27 A60 ECO 42W |

Nickel plated pendant lamp, lampshade available in any material. Colgante niquelado y pantalla disponible en cualquier material. Deckenleuchte vernickelt, Schirm in allen Materialien verfügbar. Lustre nickelés, abat-jour disponible dans n'importe quel matériel.



MATERIALS

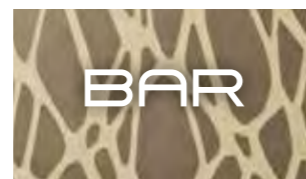

tejido semi-translúcido
flocked fabric
geflockter Stoff
tissu floqué

p 298

SRM ADM

Equipo ElTorrent



SERENA

Equipo ElTorrent

CE □ V IP20

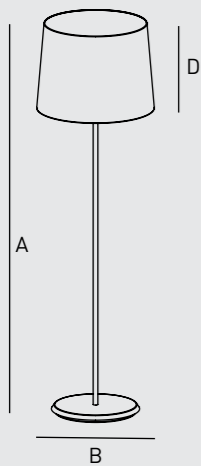

| ref | A | BØ | C | D | DIF | A | A+ | B |
|--------|-------|------|---|------|-----|----------------|---------------|--------------------|
| SR.444 | 162cm | 40cm | | 25cm | | 1xE-27 FLC 25W | 1xE27 LED 12W | 1xE-27 A60 ECO 42W |

Floor lamp with nickel plated base, lampshade available in any material.

Modelo con base niquelada y pantalla disponible en cualquier material.

Modell, vernickelte Basis, Schirm in allen Materialien verfügbar.

Modèle à base nickelée, abat-jour disponible dans n'importe quel matériel.

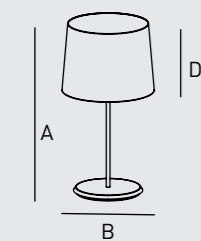

| ref | A | BØ | C | D | DIF | A | A+ | B |
|--------|------|------|---|------|-----|----------------|---------------|--------------------|
| SR.442 | 40cm | 18cm | | 13cm | | 1xE-27 FLC 25W | 1xE27 LED 12W | 1xE-27 A60 ECO 42W |
| SR.443 | 72cm | 30cm | | 20cm | | 1xE-27 FLC 25W | 1xE27 LED 12W | 1xE-27 A60 ECO 42W |

Table lamp with nickel plated base, lampshade available in any material.

Modelo con base niquelada y pantalla disponible en cualquier material.

Modell, vernickelte Basis, Schirm in allen Materialien verfügbar.

Modèle à base nickelée, abat-jour disponible dans n'importe quel matériel.

MATERIALS



cotton
tejido algodón
baumwollstoff
tissu coton

p 298





DONNA

Eloy Puig



DONNA

Eloy Puig

CE □ V IP20

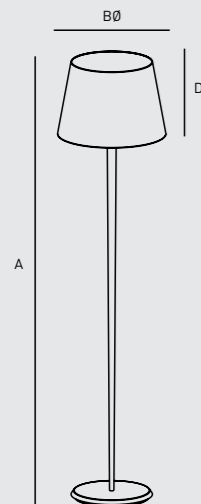

| ref | A | BØ | C | D | DIF | A | A+ | B |
|--------|-------|------|---|------|-----|----------------|---------------|--------------------|
| DN.429 | 170cm | 40cm | | 28cm | | 1xE-27 FLC 25W | 1xE27 LED 12W | 1xE-27 A60 ECO 42W |

Floor lamp with chromed conical body, lampshade available in any material.

Modelo de cuerpo cónico cromado y pantalla disponible en cualquier material.

Modell mit kegelförmigem, verchromtem Körper, Schirm in allen Materialien verfügbar.

Modèle à corps conique chromé, abat-jour disponible dans n'importe quel matériel.

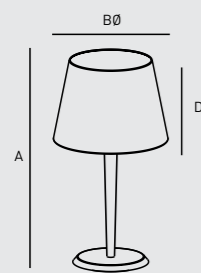

| ref | A | BØ | C | D | DIF | A | A+ | B |
|--------|------|------|---|------|-----|----------------|---------------|--------------------|
| DN.427 | 48cm | 25cm | | 20cm | | 1xE-27 FLC 21W | 1xE27 LED 12W | 1xE-27 A60 ECO 42W |
| DN.428 | 80cm | 40cm | | 28cm | | 1xE-27 FLC 25W | 1xE27 LED 12W | 1xE-27 A60 ECO 42W |

Table lamp with chromed conical body, lampshade available in any material.

Modelo de cuerpo cónico cromado y pantalla disponible en cualquier material.

Modell mit kegelförmigem, verchromtem Körper, Schirm in allen Materialien verfügbar.

Modèle à corps conique chromé, abat-jour disponible dans n'importe quel matériel.

MATERIALS



tejido semi-transparente

p. 298





XÉ NIA

Eloy Puig







XÈNIA

Eloy Puig

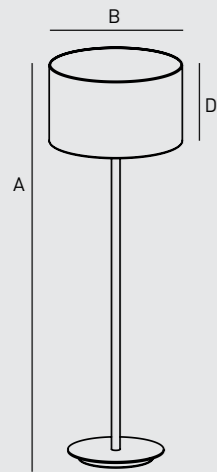
CE   IP20



| ref | ref | ref | A | BØ | C | DIF | A | A+ | B |
|--------|--------|--------|-------|------|------|-----|----------------|---------------|--------------------|
| XE.321 | XE.332 | XE.342 | 160cm | 45cm | 25cm | ✓ | 1xE-27 FLC 21W | 1xE27 LED 12W | 1xE-27 A60 ECO 42W |

 Floor lamp with chromed, black or white body. Lampshade available in any material. Modelo pie con cuerpo cromado, negro o blanco. Pantalla disponible en cualquier material. Stehlampenmodell mit verchromtem Körper, schwarz oder weiß. Schirm in allen Materialien erhältlich. Lampadaire chromé, noir ou blanc. Abat-jour disponible dans tous les matériaux.

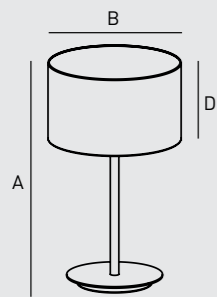

| ref | ref | ref | A | BØ | C | DIF | A | A+ | B |
|--------|--------|--------|------|------|------|-----|----------------|--------------|--------------------|
| XE.320 | XE.330 | XE.340 | 45cm | 25cm | 20cm | ✓ | 1xE-27 FLC 21W | 1xE27 LED 9W | 1xE-27 A60 ECO 42W |
| XE.329 | XE.331 | XE.341 | 75cm | 35cm | 25cm | ✓ | 1xE-27 FLC 21W | 1xE27 LED9W | 1xE-27 A60 ECO 42W |

 Table lamp with chromed, black or white body. Lampshade available in any material. Modelo mesa con cuerpo cromado, negro o blanco. Pantalla disponible en cualquier material. Tischlampenmodell mit verchromtem Körper, schwarz oder weiß. Schirm in allen Materialien erhältlich. Modèle à poser chromé, noir ou blanc. Abat-jour disponible dans tous les matériaux.

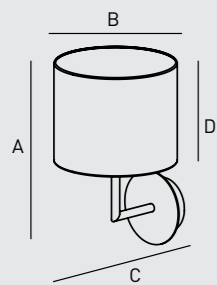

| ref | ref | ref | A | BØ | C | D | DIF | A | A+ | B |
|--------|--------|--------|------|------|------|------|-----|---------------|--------------|-------------------|
| XE.323 | XE.333 | XE.343 | 29cm | 18cm | 20cm | 15cm | ✓ | 1xE-27FLC 21W | 1xE27 LED 5W | 1xE-27P45 ECO 24W |

 Wall lamp with chromed, black or white body. Lampshade available in any material. Aplique con cuerpo cromado, negro o blanco. Pantalla disponible en cualquier material. Wandlampe mit verchromtem Körper, schwarz oder weiß. Schirm in allen Materialien erhältlich. Applique chromée, noir ou blanc. Abat-jour disponible dans tous les matériaux.



MATERIALS



organdie
organza
organza
organza
p 298



Eloy Puig

NATUR

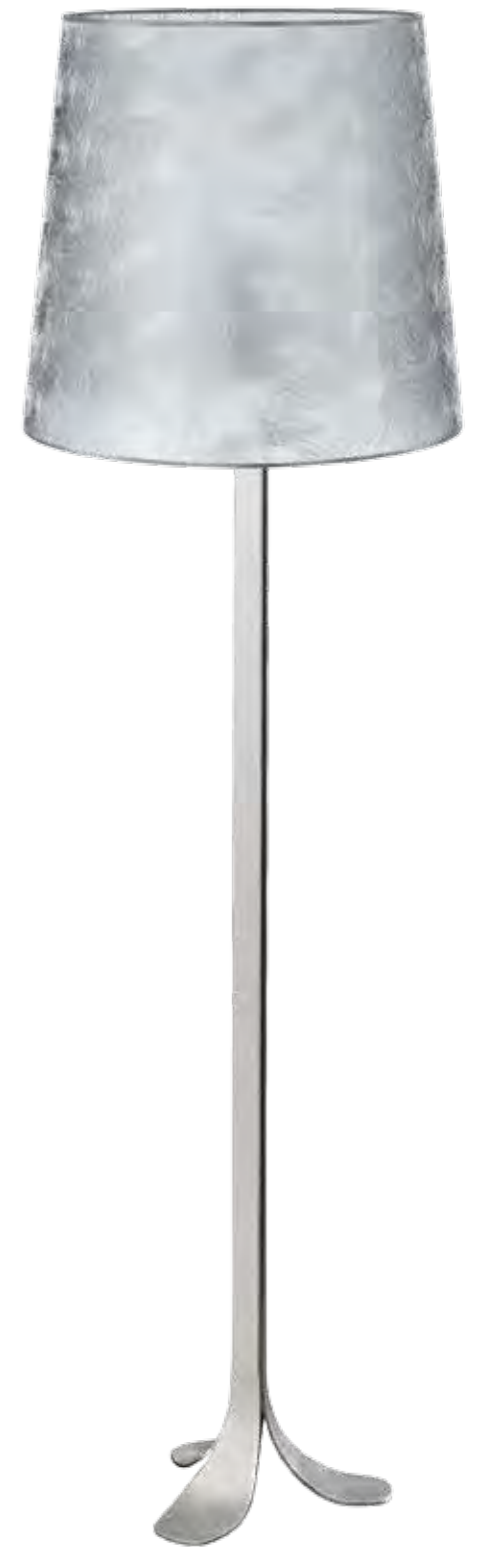

NATUR

Eloy Puig

CE □ V IP20

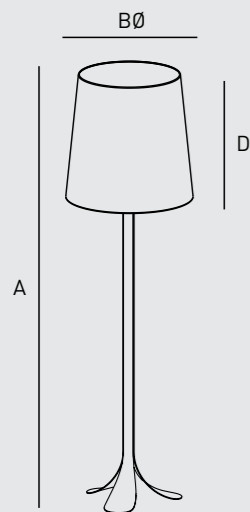

| ref | A | BØ | C | D | DIF | A | A+ | B |
|--------|-------|------|---|------|-----|----------------|---------------|--------------------|
| NT.422 | 170cm | 50cm | | 50cm | | 1xE-27 FLC 25w | 1xE27 LED 12W | 1xE-27 A60 ECO 42W |

Floor lamp with nickel plated body, lampshade available in any material.

Modelo de pie con cuerpo niquelado y pantalla disponible en cualquier material.

Stehlampe mit vernickeltem oder Körper, Schirm in allen Materialien verfügbar.

Modèle sur pied à corps nickelé, abat-jour disponible dans n'importe quel matériel.

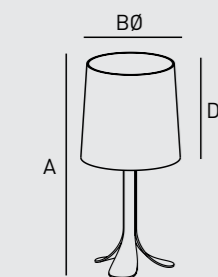

| ref | A | BØ | C | D | DIF | A | A+ | B |
|--------|------|------|---|------|-----|----------------|---------------|--------------------|
| NT.090 | 46cm | 20cm | | 20cm | | 1xE-27 FLC 25W | 1xE27 LED 12W | 1xE-27 A60 ECO 42W |

Table lamp with nickel plated body, lampshade available in any material.

Modelo de mesa con cuerpo niquelado y pantalla disponible en cualquier material.

Tischmodell mit vernickeltem oder Körper, Schirm in allen Materialien verfügbar.

Modèle de table à corps nickelé, abat-jour disponible dans n'importe quel matériel.

MATERIALS



embroidered organza
organza bordada
bestickter Organza
organza brodé

p 298



NEO

Equipo ElTorrent





NEO

Equipo ElTorrent

CE IP20

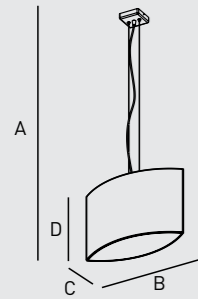

| ref | A | B | C | D | DIF | A | A+ |
|--------|-------|------|------|------|-----|----------------|---------------|
| NE.509 | 130cm | 45cm | 17cm | 30cm | | 1xE-27 FLC 25W | 1xE27 LED 12W |

Nickel plated pendant lamp. Lampshade available in any material. Colgante niquelado. Pantalla disponible en cualquier material. Hänge vernickelt. Schirm in jedem Material erhältlich. Lustre nickelés. Abat-jour disponible dans n'importe quel matériel.

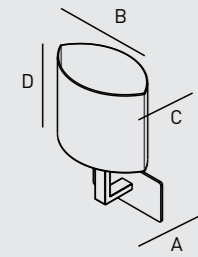

| ref | A | B | C | D | DIF | A | A+ |
|--------|--------|------|------|------|-----|----------------|---------------|
| NE.508 | 17,5cm | 25cm | 15cm | 20cm | | 1xE-27 FLC 25W | 1xE27 LED 12W |

Nickel plated wall-light. Lampshade available in any material. Aplique niquelado. Pantalla disponible en cualquier material. Wandlampe vernickelt. Schirm in jedem Material erhältlich. Applique nickelés. Abat-jour disponible dans n'importe quel matériel.

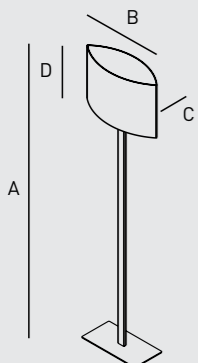

| ref | A | B | C | D | DIF | A | A+ |
|--------|-------|------|------|------|-----|----------------|---------------|
| NE.507 | 165cm | 45cm | 17cm | 30cm | | 1xE-27 FLC 25W | 1xE27 LED 12W |

Nickel plated floor lamp. Lampshade available in any material. Modelo de pie niquelado. Pantalla disponible en cualquier material. Steh vernickelt. Schirm in jedem Material erhältlich. Modèle sur pied nickelé. Abat-jour disponible dans n'importe quel matériel.

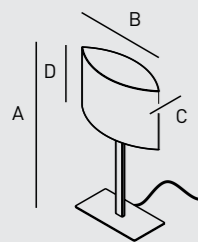

| ref | A | B | C | D | DIF | A | A+ |
|--------|------|------|------|------|-----|----------------|---------------|
| NE.505 | 41cm | 25cm | 12cm | 20cm | | 1xE-27 FLC 25W | 1xE27 LED 12W |
| NE.506 | 75cm | 45cm | 17cm | 30cm | | 1xE-27 FLC 25W | 1xE27 LED 12W |

Table lamp. Lampshade available in any material. Modelo de mesa niquelado. Pantalla disponible en cualquier material. Tischmodell vernickelt. Schirm in jedem Material erhältlich. Modèle sur table nickelé. Abat-jour disponible dans n'importe quel matériel.



MATERIALS



taffeta
tafetán
taft
taffetas
p 298

Eloy Puig

DOU CEE





DOUCE

Eloy Puig

CE V IP20

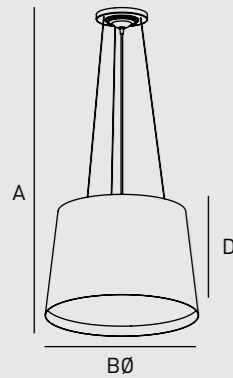

| ref | A | BØ | C | D | DIF | A | A+ | B |
|--------|-------|------|---|------|-----|----------------|---------------|--------------------|
| DC.032 | 130cm | 40cm | | 27cm | ✓ | 1xE-27 FLC 21W | 1xE27 LED 12W | 1xE-27 A60 ECO 42W |
| DC.033 | 130cm | 50cm | | 34cm | ✓ | 3xE-27 FLC 21W | 3xE27 LED 12W | 3xE-27 A60 ECO 42W |
| DC.034 | 130cm | 60cm | | 40cm | ✓ | 3xE-27 FLC 21W | 3xE27 LED 12W | 3xE-27 A60 ECO 42W |
| DC.409 | 130cm | 80cm | | 40cm | ✓ | 3xE-27 FLC 21W | 3xE27 LED 12W | 3xE-27 A60 ECO 42W |

Chromed and black graphite pendant lamp, lampshade available in any material.
 Colgante cromado y de grafito negro. Pantalla disponible en cualquier material.
 Hänge verchromt und mit schwarzem Grafit, Schirm in allen Materialien verfügbar.
 Lustre chromés et graphite noir, abat-jour disponible dans n'importe quel matériel.

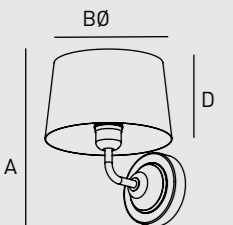

| ref | A | BØ | C | D | DIF | A | A+ | B |
|--------|------|------|---|------|-----|----------------|---------------|--------------------|
| DC.065 | 25cm | 18cm | | 13cm | | 1xE-27 FLC 25W | 1xE27 LED 12W | 1xE-27 A60 ECO 24W |

Chromed and black graphite wall lamp, lampshade available in any material.
 Aplique cromado y de grafito negro. Pantalla disponible en cualquier material.
 Wandlampe verchromt und mit schwarzem Grafit, Schirm in allen Materialien verfügbar.
 Applique chromés et graphite noir, abat-jour disponible dans n'importe quel matériel.

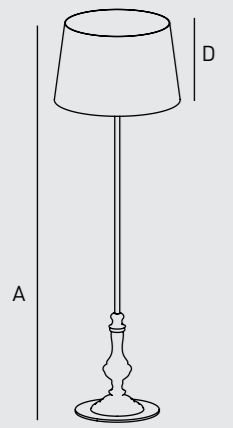

| ref | A | BØ | C | D | DIF | A | A+ | B |
|--------|-------|------|---|------|-----|----------------|---------------|--------------------|
| DC.030 | 175cm | 50cm | | 34cm | | 1xE-27 FLC 25W | 1xE27 LED 12W | 1xE-27 A60 ECO 42W |

Floor with chromed and black graphite body, lampshade available in any material.
 Modelo de pie con cuerpo cromado y de grafito negro. Pantalla disponible en cualquier material.
 Steh Körper verchromt und mit schwarzem Grafit, Schirm in allen Materialien verfügbar.
 Modèle sur pied à corps chromé et graphite noir, abat-jour disponible dans n'importe quel matériel.

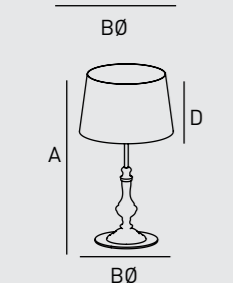

| ref | A | BØ | C | D | DIF | A | A+ | B |
|--------|------|------|---|------|-----|----------------|---------------|--------------------|
| DC.028 | 55cm | 30cm | | 20cm | | 1xE-27 FLC 21W | 1xE27 LED 12W | 1xE-27 A60 ECO 42W |

Table lamp with chromed and black graphite body, lampshade available in any material.
 Modelo de mesa con cuerpo cromado y de grafito negro. Pantalla disponible en cualquier material.
 Tischmodell, Körper verchromt und mit schwarzem Grafit, Schirm in allen Materialien verfügbar.
 Modèle sur table à corps chromé et graphite noir, abat-jour disponible dans n'importe quel matériel.



MATERIALS



embroidered organdie
 organza bordada
 bestickter Organza
 organza brodé

p 298



Eloy Puig

TELMA

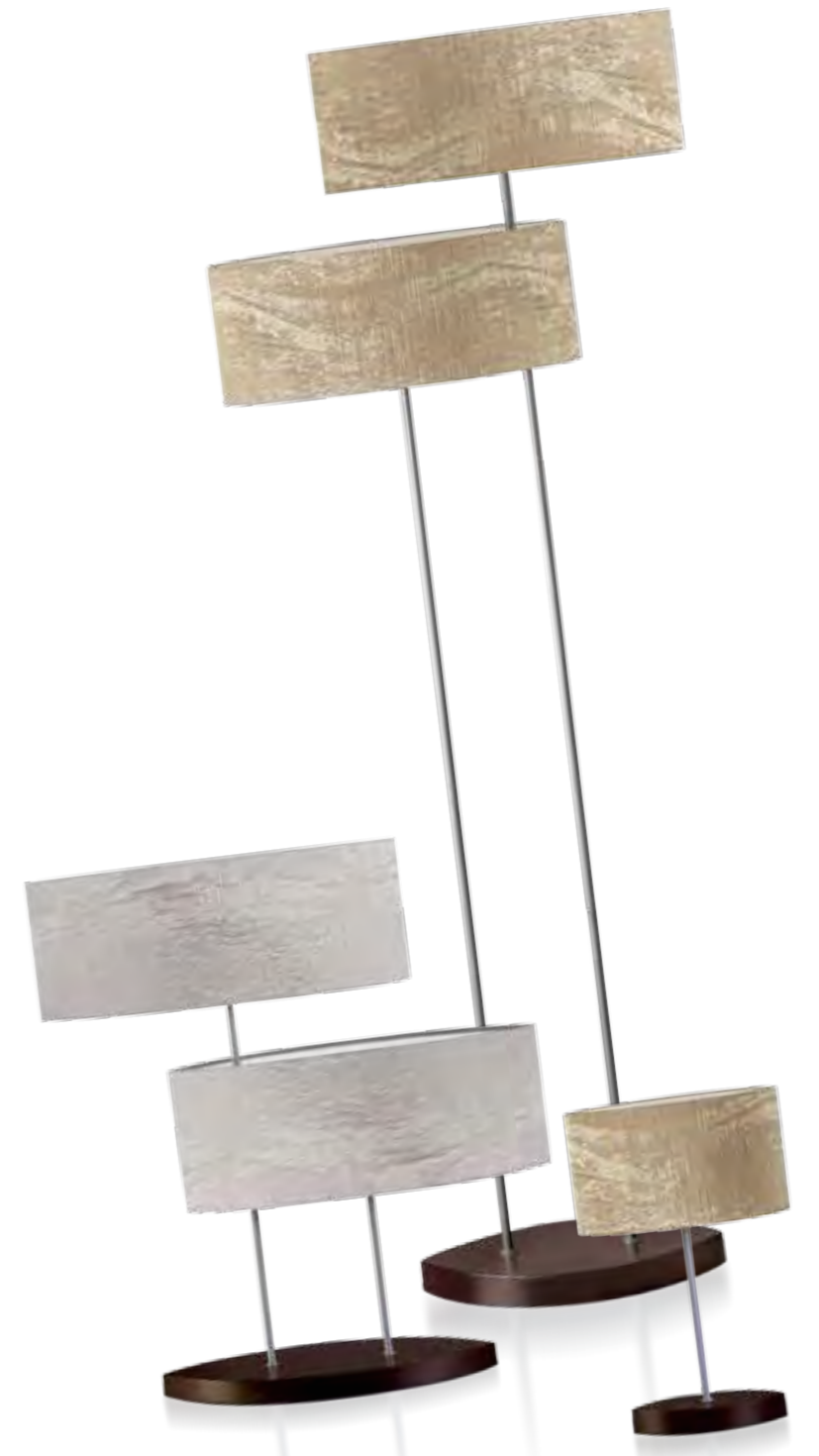

TELMA

Eloy Puig

CE □ V IP20

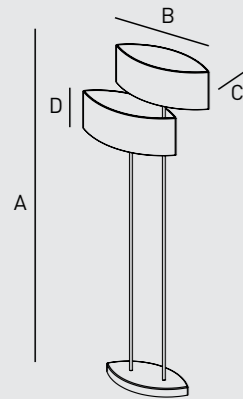

| ref | A | B | C | D | DIF | A | A+ |
|--------|-------|------|------|------|-----|----------------|---------------|
| TE.319 | 160cm | 60cm | 16cm | 18cm | | 2xE-27 FLC 25W | 2xE27 LED 12W |

Floor lamp with wengue-coloured wooden base and grey metal body. Lampshade available in any material.

Modelo de pie con base de madera de color wengué y cuerpo de metal gris. Pantalla disponible en cualquier material.

Steh mit Basis aus wengefarbenem Holz und Körper aus grauem Metall, Schirm in allen Materialien verfügbar.

Modèle sur pied à base bois couleur wengé et corps métal gris, abat-jour disponible dans n'importe quel matériel.

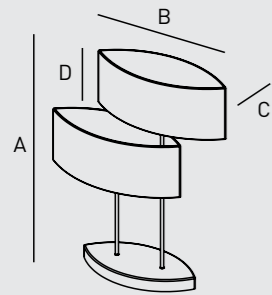

| ref | A | B | C | D | DIF | A | A+ |
|--------|------|------|------|------|-----|----------------|---------------|
| TE.318 | 70cm | 60cm | 16cm | 18cm | | 2xE-27 FLC 25W | 2xE27 LED 12W |

Table lamp with wengue-coloured wooden base and grey metal body. Lampshade available in any material.

Modelo de mesa con base de madera de color wengué y cuerpo de metal gris. Pantalla disponible en cualquier material.

Tischmodell mit Basis aus wengefarbenem Holz und Körper aus grauem Metall, Schirm in allen Materialien verfügbar.

Modèle de table à base bois couleur wengé et corps métal gris, abat-jour disponible dans n'importe quel matériel.

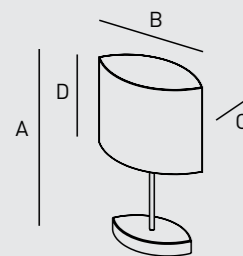

| ref | A | B | C | D | DIF | A | A+ |
|--------|------|------|------|------|-----|----------------|--------------|
| TE.317 | 40cm | 25cm | 10cm | 15cm | | 1xE-27 FLC 20w | 1xE27 LED 8W |

Table lamp with wengue-coloured wooden base and grey metal body. Lampshade available in any material.

Modelo portátil con base de madera de color wengué y cuerpo de metal gris. Pantalla disponible en cualquier material.

Tischmodell mit Basis aus wengefarbenem Holz und Körper aus grauem Metall, Schirm in allen Materialien verfügbar.

Modèle de table à base bois couleur wengé et corps métal gris, abat-jour disponible dans n'importe quel matériel.



MATERIALS



linen
tejido poliester
leinenstoff
tissu lin

p 298

El Torrent

NUVIA



NUVIA

El Torrent

CE □ V IP20

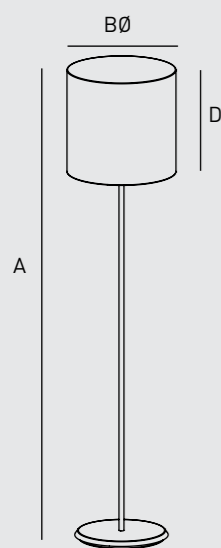

| ref | A | BØ | C | D | DIF | A | A+ | B |
|--------|-------|------|---|------|-----|----------------|---------------|--------------------|
| NV.433 | 170cm | 35cm | | 35cm | | 1xE-27 FLC 25W | 1xE27 LED 12W | 1xE-27 A60 ECO 42W |

Floor lamp with nickel plated base, lampshade available in any material.

Modelo con base niquelada y pantalla disponible en cualquier material.

Modell, vernickelte Basis, Schirm in allen Materialien verfügbar.

Modèle à base nickelée, abat-jour disponible dans n'importe quel matériel.

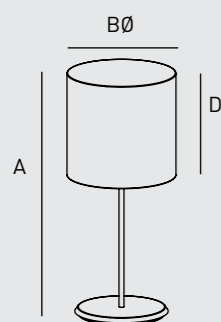

| ref | A | BØ | C | D | DIF | A | A+ | B |
|--------|------|------|---|------|-----|----------------|--------------|--------------------|
| NV.431 | 43cm | 18cm | | 18cm | | 1xE-27 FLC 21W | 1xE27 LED 8W | 1xE-27 A60 ECO 42W |
| NV.432 | 80cm | 35cm | | 35cm | | 1xE-27 FLC 21W | 1xE27 LED 8W | 1xE-27 A60 ECO 42W |

Table lamp with nickel plated base, lampshade available in any material.

Modelo de mesa con base niquelada y pantalla disponible en cualquier material.

Modell, vernickelte Basis, Schirm in allen Materialien verfügbar.

Modèle à base nickelée, abat-jour disponible dans n'importe quel matériel.

MATERIALS



embroidered organza
organza bordada
bestickter Organza
organza brodé

p 298



Eloy Puig

LIA





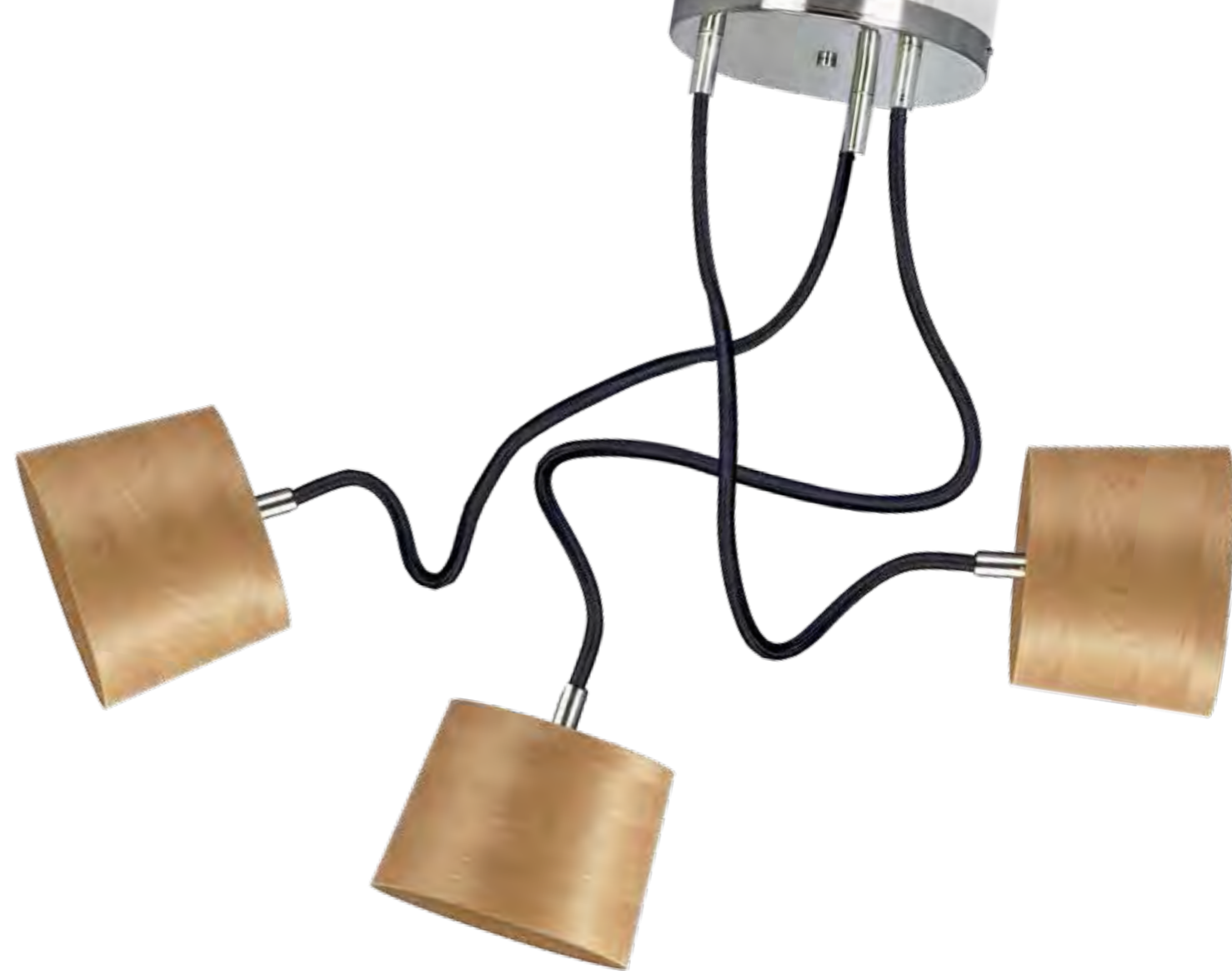

LIA

Eloy Puig

CE IP20

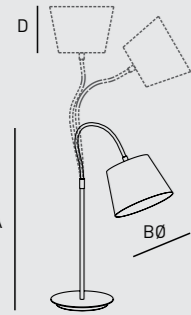

| ref | A | BØ | C | D | DIF | A | A+ | B |
|--------|-------|------|---|------|-----|----------------|---------------|--------------------|
| LA.435 | 160cm | 25cm | | 20cm | | 1xE-27 FLC 25W | 1xE27 LED 12W | 1xE-27 A60 ECO 42W |
| LA.498 | 80cm | 25cm | | 20cm | | 1xE-27 FLC 32W | 1xE27 LED 12W | 1xE-27 A60 ECO 42W |

Floor and table lamp with chromed base and fabric cable. Lampshade available in any material.

Modelo con base cromada y flexo textil. Pantalla disponible en cualquier material.

Modell, verchromte Basis und Schlauch aus mit Metallschicht versehenem Stoff, Schirm in allen Materialien verfügbar.

Modèle à base chromée et tige textile, abat-jour disponible dans n'importe quel matériel.

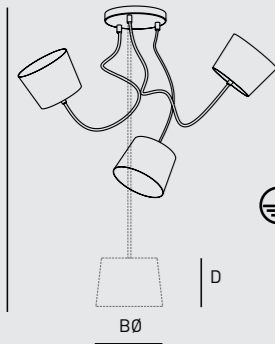

| ref | A | BØ | C | D | DIF | A | A+ | B |
|--------|-------|--------|---|------|-----|----------------|---------------|--------------------|
| LA.071 | 100cm | 18cm | | 15cm | | 1xE-27 FLC 25W | 1xE27 LED 9W | 1xE-27 P45 ECO 42W |
| LA.104 | 100cm | 3x18cm | | 15cm | | 3xE-27 FLC 32W | 3xE27 LED 12W | 3xE-27 P45 ECO 42W |

Chrome pendant lamp, fabric cable, lampshade available in any material.

Colgante cromado y flexo textil. Pantalla disponible en cualquier material.

Deckenleuchte verchromt und Schlauch aus mit Metallschicht versehenem Stoff, Schirm in allen Materialien verfügbar.

Lustre chromés et tige textile, abat-jour disponible dans n'importe quel matériel.

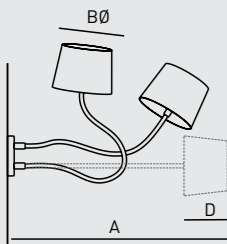

| ref | A | BØ | C | D | DIF | A | A+ | B |
|--------|------|--------|---|------|-----|----------------|--------------|--------------------|
| LA.107 | 40cm | 18cm | | 15cm | | 1xE-27 FLC 25W | 1xE27 LED 5W | 1xE-27 P45 ECO 42W |
| LA.110 | 40cm | 2x18cm | | 15cm | | 2xE-27 FLC 25W | 2xE27 LED 5W | 2xE-27 P45 ECO 42W |

Chrome wall lamp, fabric cable, lampshade available in any material.

Aplique cromado y flexo textil. Pantalla disponible en cualquier material.

Wandlampe verchromt und Schlauch aus mit Metallschicht versehenem Stoff, Schirm in allen Materialien verfügbar.

Applique chromés et tige textile, abat-jour disponible dans n'importe quel matériel.



MATERIALS



varnished wood
madera laminada
lamelliertes Holz
bois stratifié

p 298

PROJECT



CasaDecor Barcelona
Spain

p 238



Eloy Puig

DAYA





DAYA

Eloy Puig

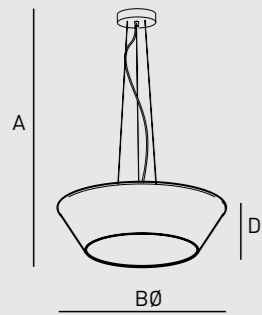
CE    IP20



| ref | A | BØ | C | D | DIF | A  | A+  | B  |
|--------|-------|------|---|------|-----|---|--|---|
| DA.048 | 130cm | 50cm | | 15cm | ✓ | 2xE-27 FLC 25W | 2xE27 LED 12W | |
| DA.049 | 130cm | 60cm | | 15cm | ✓ | 3xE-27 FLC 25W | 3xE27 LED 12W | 3xE-27 A60 ECO 42W |
| DA.050 | 130cm | 80cm | | 17cm | ✓ | 6xE-27 FLC 25W | 6xE27 LED 12W | 6xE-27 A60 ECO 42W |



Nickel plated pendant lamp, lampshade available in any material.

Colgante niquelado con pantalla disponible en cualquier material.

Deckenleuchte vernickelt, Schirm in allen Materialien verfügbar.

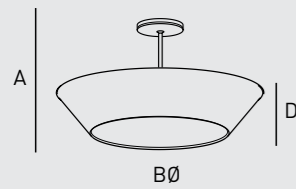
Lustre nickelé, abat-jour disponible dans n'importe quel matériel.



| ref | A | BØ | C | D | DIF | A  | A+  | B  |
|--------|------|------|---|------|-----|---|--|---|
| DA.019 | 36cm | 50cm | | 15cm | ✓ | 2xE-27 FLC 25W | 2xE27 LED 12W | |
| DA.014 | 36cm | 60cm | | 15cm | ✓ | 3xE-27 FLC 25W | 3xE27 LED 12W | 3xE-27 A60 ECO 42W |
| DA.015 | 36cm | 80cm | | 17cm | ✓ | 6xE-27 FLC 25W | 6xE27 LED 12W | 6xE-27 A60 ECO 42W |



Nickel plated support, lampshade available in any material.

Soporte niquelado y pantalla disponible en cualquier material.

Halterung vernickelt, Schirm in allen Materialien verfügbar.

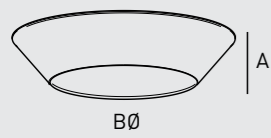
Support nickelé, abat-jour disponible dans n'importe quel matériel.



| ref | A | BØ | C | D | DIF | A  | A+  | B  |
|--------|------|------|---|---|-----|---|--|---|
| DA.045 | 15cm | 50cm | | | ✓ | 2xE-27 FLC 25W | 2xE27 LED 12W | |
| DA.046 | 15cm | 60cm | | | ✓ | 3xE-27 FLC 25W | 3xE27 LED 12W | 3xE-27 A60 ECO 42W |
| DA.047 | 17cm | 80cm | | | ✓ | 6xE-27 FLC 25W | 6xE27 LED 12W | 6xE-27 A60 ECO 42W |

Magnet fastening, lampshade available in any material.

Plafón con sujeción por imanes. Pantalla disponible en cualquier material.

Magnet Befestigung, Schirm in allen Materialien verfügbar.

fermeture magnétique disponible dans n'importe quel matériel.

MATERIALS



pleated fabrics
cinta plisada
plissiertes Band
ruban plissé

p 298





SYLVA

Eloy Puig





SYLVA

Eloy Puig

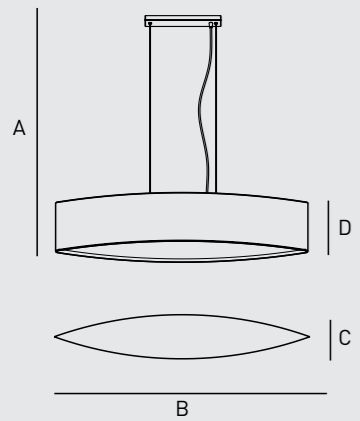
CE    IP20



| ref | A | BØ | C | D | DIF | A  | A+  |
|--------|-------|-------|------|------|-----|---|--|
| SY.010 | 130cm | 65cm | 17cm | 22cm | | 2xE-27 FLC 25W | 2xE27 LED 12W |
| SY.011 | 130cm | 100cm | 17cm | 22cm | | 4xE-27 FLC 25W | 4xE27 LED 12W |

C Nickel plated pendant lamp, lampshade available in any material.

Colgante niquelado y pantalla disponible en cualquier material.

Deckenleuchte vernickelt, Schirm in allen Materialien verfügbar.

Lustre nickelé, abat-jour disponible dans n'importe quel matériel.

MATERIALS



pleated fabrics
cinta plisada
plissiertes Band
ruban plissé

p 298





SUITE

Eloy Puig



SUITE

Eloy Puig

CE V IP20

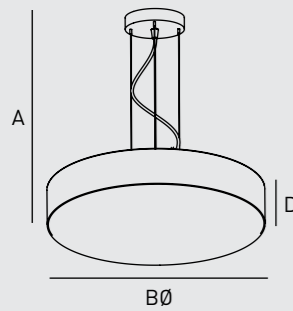

| ref | A | BØ | C | D | DIF | A | A+ | B |
|--------|-------|-------|---|------|-----|----------------|---------------|--------------------|
| SU.037 | 130cm | 45cm | | 15cm | ✓ | 3xE-27 FLC 25W | 3xE27 LED 12W | 3xE-27 A60 ECO 42W |
| SU.038 | 130cm | 60cm | | 15cm | ✓ | 3xE-27 FLC 25W | 3xE27 LED 12W | 3xE-27 A60 ECO 42W |
| SU.039 | 130cm | 80cm | | 15cm | ✓ | 6xE-27 FLC 25W | 6xE27 LED 12W | 6xE-27 A60 ECO 42W |
| SU.458 | 130cm | 100cm | | 17cm | ✓ | 6xE-27 FLC 25W | 6xE27 LED 12W | 6xE-27 A60 ECO 42W |
| SU.459 | 130cm | 120cm | | 17cm | ✓ | 6xE-27 FLC 25W | 6xE27 LED 12W | 6xE-27 A60 ECO 42W |



Nickel plated pendant lamp, lampshade available in any material.

Colgante niquelado y pantalla disponible en cualquier material.

Deckenleuchte vernickelt, Schirm in allen Materialien verfügbar.

Lustre nickelé, abat-jour disponible dans n'importe quel matériel.

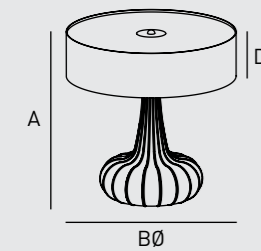

| ref | A | BØ | C | D | DIF | A | A+ |
|--------|------|------|---|------|-----|----------------|--------------|
| SU.035 | 40cm | 35cm | | 17cm | ✓ | 2xE-27 FLC 21W | 2xE27 LED 8W |



Table lamp with blown-glass body. Lampshade available in any material.

Modelo de mesa con cuerpo de cristal soplado. Pantalla disponible en cualquier material.

Tischmodell, Körper aus geblasenem Glas. Schirm in jedem Material erhältlich.

Modèle de table, corps verre soufflé. Abat-jour disponible dans n'importe quel matériel.



MATERIALS



organdie
organza
organza
organza
p 298

PROJECT



Private House
Barcelona, Spain

p 238



Eloy Puig

ARKA



ARKA

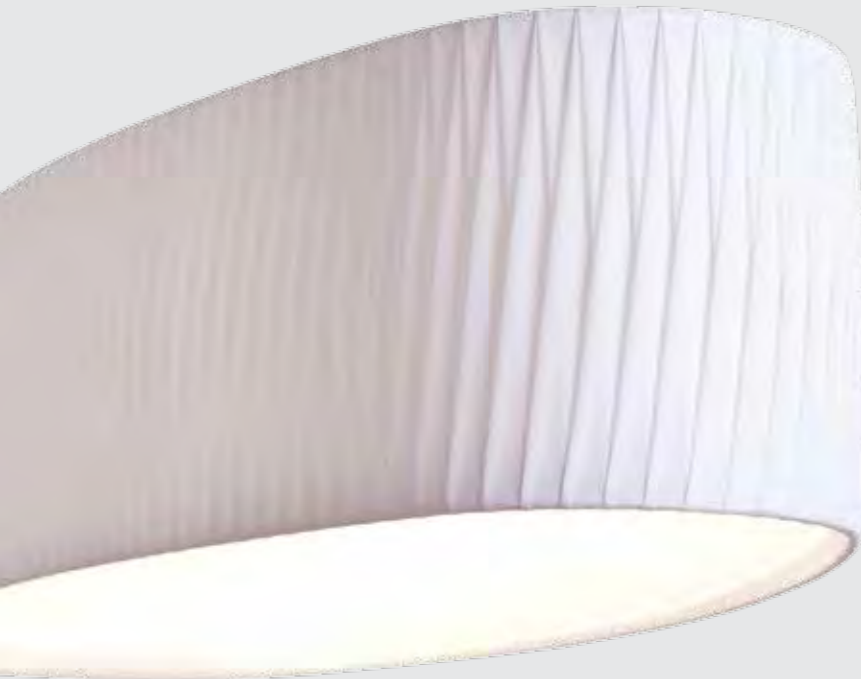

Eloy Puig

CE    IP20

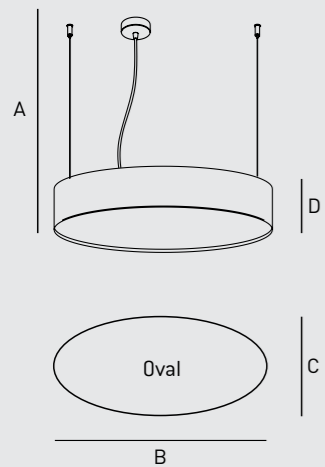

Oval lampshade
Pantalla oval
Ovaler Schirm
Abat-jour ovale



| ref | A | B | C | D | DIF | A  | A+  | B  |
|--------|-------|------|------|------|-----|---|--|---|
| AR.419 | 130cm | 65cm | 30cm | 20cm | ✓ | 2xE-27 FLC 25W | 2xE27 LED 12W | 2xE-27 A60 ECO 42W |
| AR.420 | 130cm | 95cm | 36cm | 20cm | ✓ | 4xE-27 FLC 25W | 4xE27 LED 12W | 4xE-27 A60 ECO 42W |

| ref | A | B | C | D | DIF | A  |
|-----------|-------|------|------|------|-----|---|
| AR.420.11 | 130cm | 95cm | 36cm | 20cm | ✓ | 2xT5 39W |

C Nickel plated pendant lamp, oval lampshade available in any colour. Colgante niquelado y pantalla oval disponible en cualquier material. Deckenleuchte vernickelt, ovaler Schirm verfügbar in allen Materialien. Lustre nickelé, abat-jour ovale disponible dans n'importe quel matériel

MATERIALS



cross-pleated band
cinta plisada cruzada
Über Kreuz plissiertes Band
bande plissée croisée

p 298





El Torrent

AN DREA





ANDREA

El Torrent

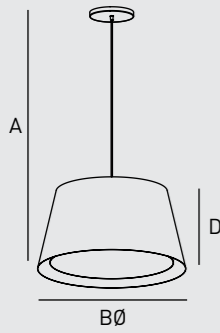
CE    IP20



| ref | A | BØ | C | D | DIF | A  | A+  | B  |
|--------|-------|------|---|------|-----|---|--|---|
| AN.007 | 130cm | 40cm | | 27cm | ✓ | 1xE-27 FLC 25W | 1xE-27 LED12w | 1xE-27 A60 ECO 42W |



Chromed pendant light, lampshade available in any material, except BBQ, BNQ, DMN, DMW

Colgante cromado y pantalla disponible en cualquier material, excepto DDG, DDN, DGB.

Verchromte Deckenleuchte, Schirm in allen Materialien, außer BBQ, BNQ, DMN, DMW

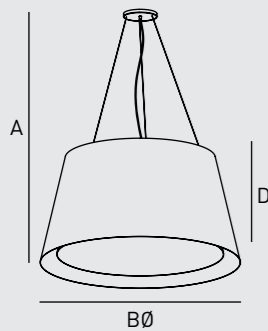
Lustre chromé, abat-jour disponible dans n'importe quel matériel, sauf BBQ, BNQ, DMN, DMW



| ref | A | BØ | C | D | DIF | A  | A+  | B  |
|--------|-------|-------|---|------|-----|---|--|---|
| AN.008 | 150cm | 50cm | | 34cm | ✓ | 3xE-27 FLC 25W | 3xE-27 LED12w | 3xE-27 A60 ECO 42W |
| AN.009 | 150cm | 60cm | | 40cm | ✓ | 3xE-27 FLC 25W | 3xE-27 LED12w | 3xE-27 A60 ECO 42W |
| AN.129 | 150cm | 80cm | | 40cm | ✓ | 6xE-27 FLC 25W | 6xE-27 LED12w | 6xE-27 A60 ECO 42W |
| AN.130 | 150cm | 100cm | | 40cm | ✓ | 6xE-27 FLC 25W | 6xE-27 LED12w | 6xE-27 A60 ECO 42W |
| AN.131 | 150cm | 120cm | | 45cm | ✓ | 6xE-27 FLC 25W | 6xE-27 LED12w | 6xE-27 A60 ECO 42W |

Chromed pendant lamp, lampshade available in any material, except BBQ, BNQ, DMN, DMW

Colgante cromado y pantalla disponible en cualquier material, excepto DDG, DDN, DGB.

Verchromte Deckenleuchte, Schirm in allen Materialien, außer BBQ, BNQ, DMN, DMW

Lustre chromé, abat-jour disponible dans n'importe quel matériel, sauf BBQ, BNQ, DMN, DMW

MATERIALS



cotton
tejido algodón
baumwollstoff
tissu coton

p 298

PROJECT



Private apartment, Prague
Czech Republic

p 239

KEOPS

El Torrent





KEOPS

El Torrent

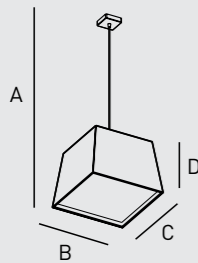
CE    IP20



| ref | A | B | C | D | DIF | A  | A+  | B  |
|--------|-------|------|------|------|-----|---|--|---|
| KE.111 | 130cm | 40cm | 40cm | 30cm | ✓ | 1xE27 FLC 32W | 1xE27 LED 12W | 1xE-27 A60 ECO 42W |



Chromed pendant lamp, lampshade available in any material.

Colgante cromado y pantalla disponible en cualquier material.

Verchromte Deckenleuchte, Schirm in allen Materialien verfügbar.

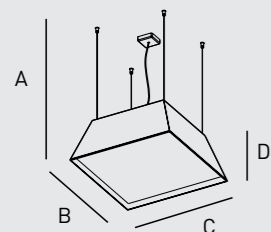
Lustre chromé, abat-jour disponible dans n'importe quel matériel.



| ref | A | B | C | D | DIF | A  | A+  | B  |
|--------|-------|------|------|------|-----|---|--|---|
| KE.112 | 130cm | 50cm | 50cm | 30cm | ✓ | 3xE27 FLC 32W | 3xE27 LED 12W | 3xE-27 A60 ECO 42W |
| KE.113 | 130cm | 70cm | 70cm | 30cm | ✓ | 4xE27 FLC 32W | 4xE27 LED 12W | 4xE-27 A60 ECO 42W |
| KE.114 | 130cm | 90cm | 90cm | 35cm | ✓ | 4xE27 FLC 32W | 4xE27 LED 12W | 4xE-27 A60 ECO 42W |



Chromed pendant lamp, lampshade available in any material.

Colgante cromado y pantalla disponible en cualquier material.

Verchromte Deckenleuchte, Schirm in allen Materialien verfügbar.

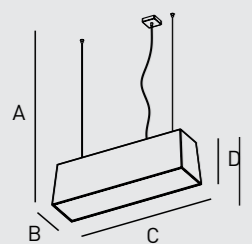
Lustre chromé, abat-jour disponible dans n'importe quel matériel.



| ref | A | B | C | D | DIF | A  | A+  | B  |
|--------|-------|------|------|------|-----|---|--|---|
| KE.514 | 130cm | 25cm | 90cm | 30cm | ✓ | 4xE27 FLC 25W | 4xE27 LED 12W | 4xE-27 A60 ECO 42W |

Chromed pendant lamp, lampshade available in any material.

Colgante cromado y pantalla disponible en cualquier material.

Verchromte Deckenleuchte, Schirm in allen Materialien verfügbar.

Lustre chromé, abat-jour disponible dans n'importe quel matériel.



MATERIALS



pleated fabrics
cinta plisada
plissiertes Band
ruban plissé

p 298



Eloy Puig

AFFRO



AFRO

Eloy Puig

CE V IP20



| ref | A | B | C | D | DIF | A | A+ | B |
|--------|-------|------|------|------|-----|----------------|---------------|--------------------|
| AF.417 | 130cm | 20cm | 65cm | 25cm | ✓ | 2xE-27 FLC 25W | 2xE27 LED 12W | 2xE-27 A60 ECO 42W |
| AF.418 | 130cm | 20cm | 90cm | 25cm | ✓ | 3xE-27 FLC 25W | 3xE27 LED 12W | 3xE-27 A60 ECO 42W |



Nickel pendant lamp with wengue body, lampshade available in any material, except BBQ, BNQ, DMN, DMW

Colgante niquelado con cuerpo de madera wengué y pantalla disponible en cualquier material, excepto BBQ, BNQ, DMN, DMW.

Deckenleuchte vernickelt, Körper aus Wenge-Holz, Schirm in allen Materialien, außer BBQ, BNQ, DMN, DMW

Lustre nickelé, corps en bois wengé, abat-jour disponible dans n'importe quel matériel, sauf BBQ, BNQ, DMN, DMW

| ref | A | B | C | D | DIF | A | A+ | B |
|--------|------|------|------|------|-----|----------------|---------------|--------------------|
| AF.271 | 24cm | 12cm | 20cm | 18cm | | 1xE-27 FLC 9W | 1xE27 LED 5W | 1xEco Classic 24W |
| AF.272 | 38cm | 16cm | 40cm | 30cm | | 1xE-27 FLC 21W | 1xE27 LED 12W | 1xE-27 A60 ECO 42W |



Table lamp with wengue body, lampshade available in any material, except BBQ, BNQ, DMN, DMW

Modelo de mesa con cuerpo de madera wengué y pantalla disponible en cualquier material, excepto BBQ, BNQ, DMN, DMW.

Tischmodell, Körper aus Wenge-Holz, Schirm in allen Materialien, außer BBQ, BNQ, DMN, DMW

Modèle de table corps en bois wengé, abat-jour disponible dans n'importe quel matériel, sauf BBQ, BNQ, DMN, DMW

MATERIALS



BCR

eco-leather
ecopiel
ecopiel
éco-cuir

p 298



OBE LISTK

Eloy Puig





OBELISK

Eloy Puig

CE □ ▽ IP20



| ref | A | B0 | C | D | DIF | A  | A+  |
|--------|-------|------|------|---|-----|--|--|
| OB.275 | 45cm | 16cm | 16cm | | | 1xE-14 FLC 14w | 1xE27 LED 8W |
| OB.276 | 70cm | 21cm | 21cm | | | 1xE-27 FLC 21W | 1xE27 LED 12W |
| OB.277 | 165cm | 34cm | 34cm | | | 4xE-27 FLC 21W | 4xE27 LED 12W |

Floor and table lamp with wengue base and white cotton lampshade.

Modelo pie y mesa con base de madera wegúe y pantalla de algodón blanco.

Steh- und Tischmodell, Basis aus Wenge-Holz, Schirm aus weißer Baumwolle.

Modèle pied et table, base en bois wengé, abat-jour en coton blanc.

MATERIALS



cotton
tejido algodón
baumwollstoff
tissu coton

p 298

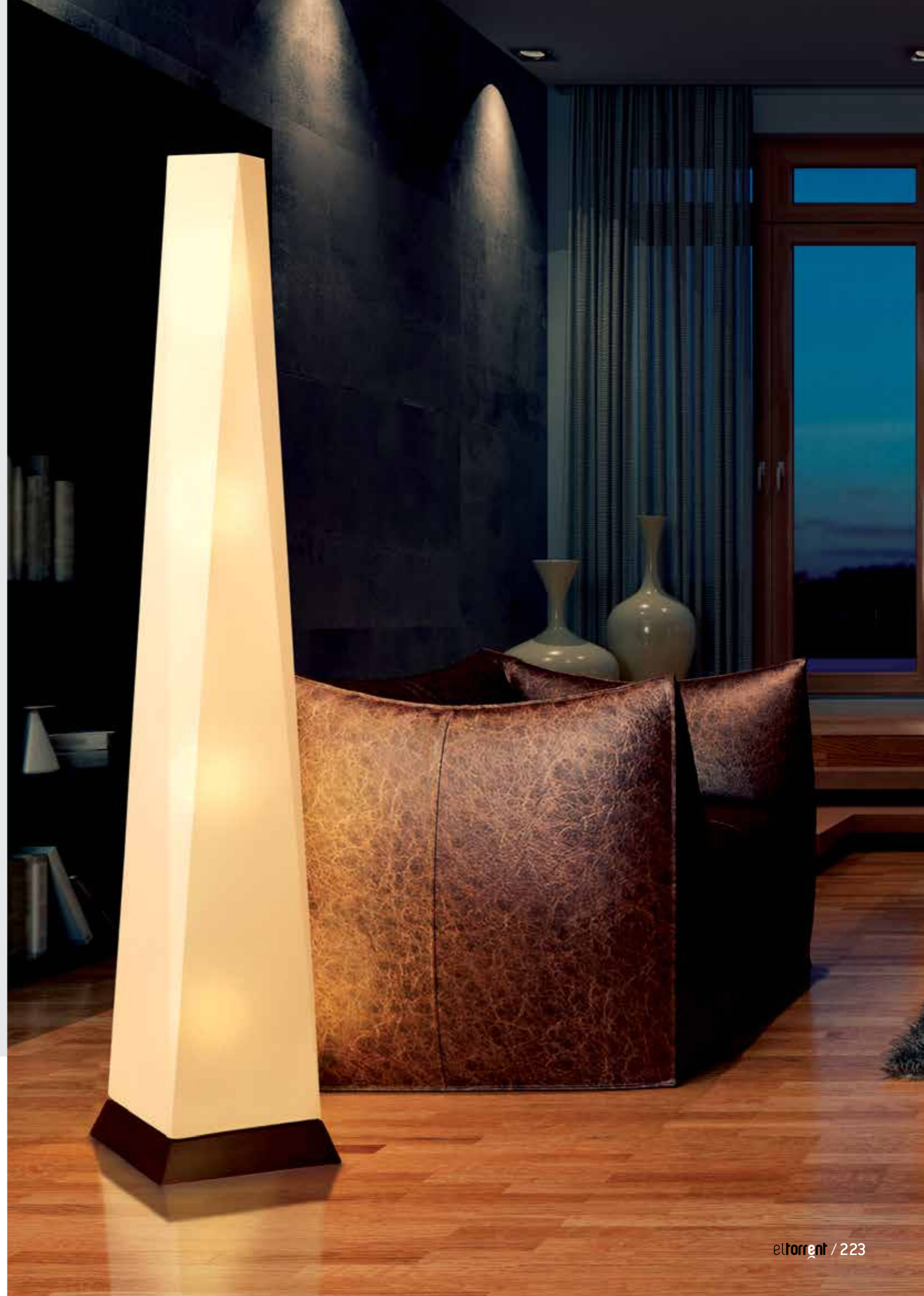

HALU

Eloy Puig



HALL

Eloy Puig

CE □ ▽ IP20

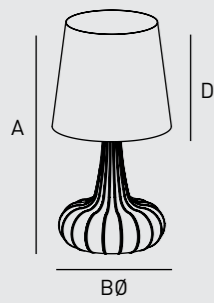

| ref | A | BØ | C | D | DIF | A | A+ | B |
|--------|------|------|---|------|-----|----------------|---------------|--------------------|
| HL.115 | 55cm | 25cm | | 20cm | | 1xE-27 FLC 25W | 1xE27 LED 12W | 1xE-27 A60 ECO 42W |

Table lamp with blown-glass body. Lampshade available in any material, except BBQ, BNQ, DMN, DMW

Modelo de mesa con cuerpo de cristal soplado. Pantalla disponible en cualquier material, excepto DDG, DDN, DGB.

Tischmodell, Körper aus geblasenem Glas. Schirm in jedem Material, außer BBQ, BNQ, DMN, DMW

Modèle de table, corps verre soufflé. Abat-jour disponible dans n'importe quel matériel, sauf BBQ, BNQ, DMN, DMW

MATERIALS



polyester fabric
tejido poliéster
polyesterstoff
tissu polyester

p 298

NAGGAR

Eloy Puig





NAGAR

Eloy Puig

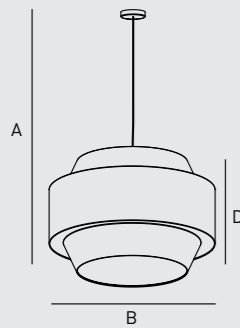
CE    IP20



| ref | A | BØ | C | D | DIF | A  | A+  | B  |
|--------|-------|------|---|------|-----|---|--|---|
| NG.075 | 150cm | 35cm | | 30cm | ✓ | 1xE-27 FLC 25W | 1xE27 LED 12W | 1xE-27 A60 ECO 42W |
| NG.076 | 150cm | 45cm | | 30cm | ✓ | 3xE-27 FLC 25W | 3xE27 LED 12W | 3xE-27 A60 ECO 42W |



Chromed pendant lamp, lampshade available in any material.

Colgante cromado y pantalla disponible en cualquier material.

Deckenleuchte verchromt, Schirm in allen Materialien verfügbar.

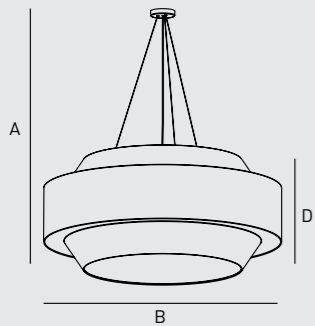
Lustre chromé, abat-jour disponible dans n'importe quel matériel



| ref | A | BØ | C | D | DIF | A  | A+  | B  |
|--------|-------|-------|---|------|-----|---|--|---|
| NG.077 | 150cm | 60cm | | 35cm | ✓ | 3xE-27 FLC 25W | 3xE27 LED 12W | 3xE-27 A60 ECO 42W |
| NG.410 | 150cm | 80cm | | 40cm | ✓ | 3xE-27 FLC 25W | 3xE27 LED 12W | 3xE-27 A60 ECO 42W |
| NG.411 | 150cm | 100cm | | 50cm | ✓ | 6xE-27 FLC 25W | 6xE27 LED 12W | 6xE-27 A60 ECO 42W |
| NG.412 | 150cm | 120cm | | 50cm | ✓ | 6xE-27 FLC 25W | 6xE27 LED 12W | 6xE-27 A60 ECO 42W |

Chromed pendant lamp, lampshade available in any material.

Colgante cromado y pantalla disponible en cualquier material.

Deckenleuchte verchromt, Schirm in allen Materialien verfügbar.

Lustre chromé, abat-jour disponible dans n'importe quel matériel

MATERIALS

BSB

BSM

wild silk
seda salvaje
wilde Seide
soie sauvage

p 298





Eloy Puig

AYUDA





AYDA

Eloy Puig

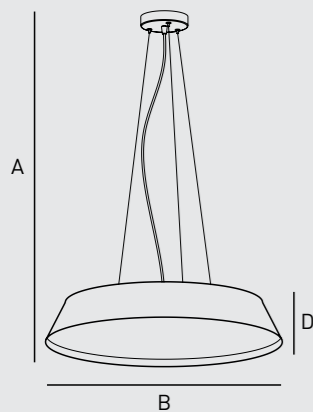
CE    IP20



| ref | A | BØ | C | D | DIF | A  | A+  | B  |
|--------|-------|------|---|------|-----|---|--|---|
| AY.040 | 130cm | 50cm | | 15cm | ✓ | 2xE-27 FLC 25W | 2xE27 LED 12W | |
| AY.041 | 130cm | 60cm | | 15cm | ✓ | 3xE-27 FLC 25W | 3xE27 LED 12W | 3xE-27 A60 ECO 42W |
| AY.042 | 130cm | 80cm | | 17cm | ✓ | 6xE-27 FLC 25W | 6xE27 LED 12W | 6xE-27 A60 ECO 42W |

Chromed pendant lamp, lampshade available in any material.

Colgante cromado y pantalla disponible en cualquier material.

Verchromte Deckenleuchte, Schirm in allen Materialien verfügbar.

Lustre chromé, abat-jour disponible dans n'importe quel matériel.

MATERIALS



wild silk
seda salvaje
wilde Seide
soie sauvage

p 298







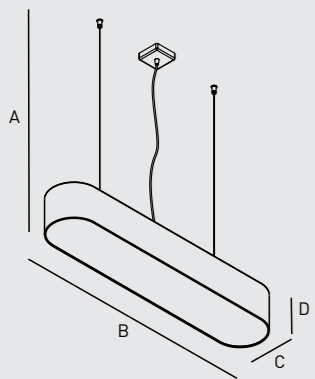

OVLA

Eloy Puig

CE    IP20



| ref | A | B0 | C | D | DIF |   |   |
|------------------|-------|-------|------|------|-----|--|---|
| OV.078 | 130cm | 100cm | 18cm | 15cm | ✓ | 4xE-27 FLC 25W | 4xE27 LED 12W |
| ref | A | B0 | C | D | DIF |   | |
| OV.078.11 | 130cm | 100cm | 18cm | 15cm | ✓ | 2xT5 39W | |

Chromed pendant lamp, lampshade available in any material.

Colgante cromado y pantalla disponible en cualquier material.

Verchromte Deckenleuchte, Schirm in allen Materialien verfügbar.

Lustre chromé, abat-jour disponible dans n'importe quel matériel.

MATERIALS



varnished wood
madera laminada
lamelliertes Holz
bois stratifié

p 298



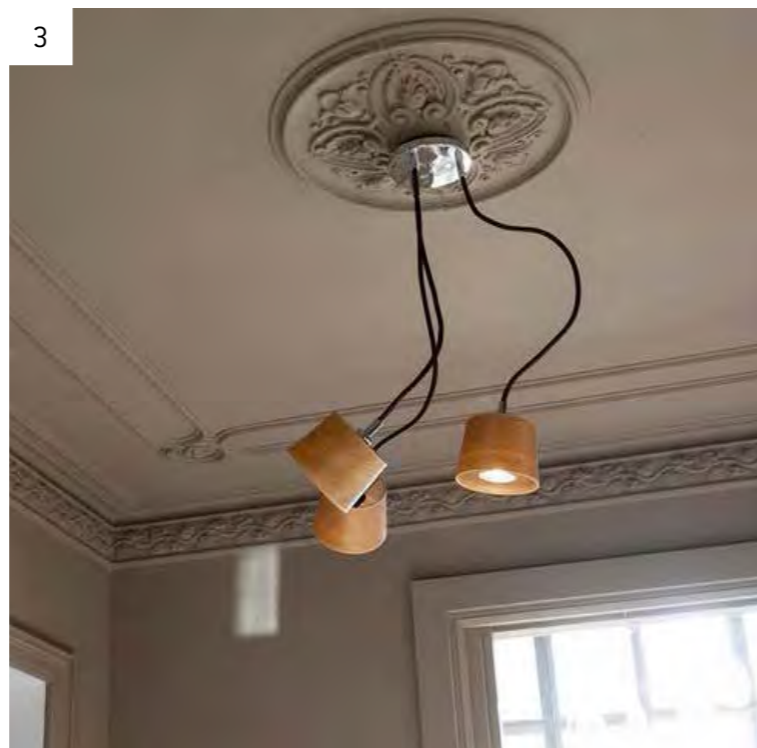

1
?????
Spain

Modelo
EVA

2
Private House
Barcelona, Spain

Modelo
SUITE

3
CasaDecor Barcelona
Spain

Modelo
LIA

4
Jorba
Spain

Modelo
EVA

5 6
Private Prague Apartment
Czech Republic

Modelo
ANDREA

SQUA RE

El Torrent





SQUARE

El Torrent

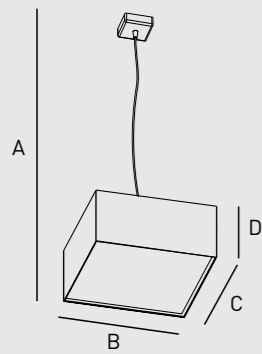
CE    IP20



| ref | A | B | C | D | DIF | A  | A+  | B  |
|---------------|-------|------|------|------|-----|---|--|---|
| SQ.051 | 130cm | 40cm | 40cm | 20cm | ✓ | 1xE-27 FLC 25W | 1xE27 LED 12W | 1xE-27 A60 ECO 42W |



Chromed pendant lamp, lampshade available in any material.

Colgante cromado y pantalla disponible en cualquier material.

Verchromte Deckenleuchte, Schirm in allen Materialien verfügbar.

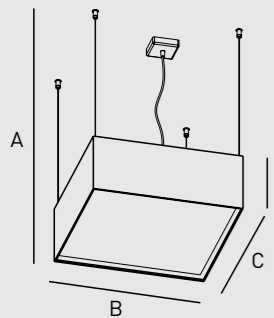
Lustre chromé, abat-jour disponible dans n'importe quel matériel.



| ref | A | B | C | D | DIF | A  | A+  | B  |
|---------------|-------|------|------|------|-----|---|--|---|
| SQ.052 | 130cm | 50cm | 50cm | 20cm | ✓ | 4xE-27 FLC 25W | 4xE27 LED 12W | 4xE-27 A60 ECO 42W |
| SQ.053 | 130cm | 70cm | 70cm | 20cm | ✓ | 4xE-27 FLC 25W | 4xE27 LED 12W | 4xE-27 A60 ECO 42W |
| SQ.510 | 130cm | 90cm | 90cm | 20cm | ✓ | 4xE-27 FLC 25W | 4xE27 LED 12W | 4xE-27 A60 ECO 42W |



Chromed pendant lamp, lampshade available in any material.

Colgante cromado y pantalla disponible en cualquier material.

Verchromte Deckenleuchte, Schirm in allen Materialien verfügbar.

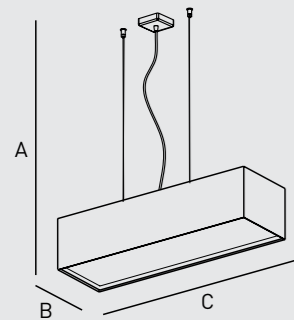
Lustre chromé, abat-jour disponible dans n'importe quel matériel.



| ref | A | B | C | D | DIF | A  | A+  | B  |
|---------------|-------|------|------|------|-----|---|--|---|
| SQ.512 | 130cm | 25cm | 70cm | 20cm | ✓ | 2xE-27 FLC 25W | 2xE27 LED 12W | 2xE-27 A60 ECO 42W |
| SQ.054 | 130cm | 25cm | 95cm | 20cm | ✓ | 4xE-27 FLC 25W | 4xE27 LED 12W | 4xE-27 A60 ECO 42W |

Chromed pendant lamp, lampshade available in any material.

Colgante cromado y pantalla disponible en cualquier material.

Verchromte Deckenleuchte, Schirm in allen Materialien verfügbar.

Lustre chromé, abat-jour disponible dans n'importe quel matériel.



MATERIALS



wild silk
seda salvaje
wilde Seide
soie sauvage

p 298

SODU RE 2X

El Torrent





SQUARE 2X

El Torrent

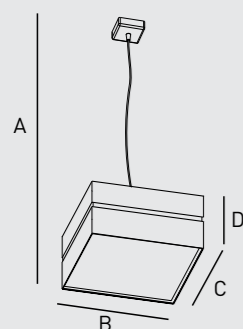
CE    IP20



| ref | A | B | C | D | DIF | A  | A+  | B  |
|---------------|-------|------|------|------|-----|---|--|---|
| SQ.059 | 130cm | 40cm | 40cm | 22cm | ✓ | 1xE-27 FLC 25W | 1xE27 LED 12W | 1xE-27 A60 ECO 42W |



Chromed pendant lamp, lampshade available in any material.

Colgante cromado y pantalla disponible en cualquier material.

Verchromte Deckenleuchte, Schirm in allen Materialien verfügbar.

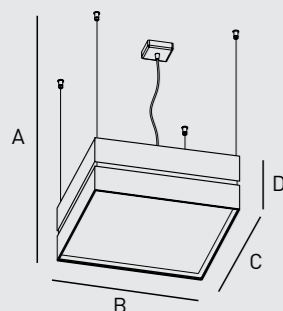
Lustre chromé, abat-jour disponible dans n'importe quel matériel.



| ref | A | B | C | D | DIF | A  | A+  | B  |
|---------------|-------|------|------|------|-----|---|--|---|
| SQ.060 | 130cm | 50cm | 50cm | 22cm | ✓ | 4xE-27 FLC 25W | 4xE27 LED 12W | 4xE-27 A60 ECO 42W |
| SQ.061 | 130cm | 70cm | 70cm | 22cm | ✓ | 4xE-27 FLC 25W | 4xE27 LED 12W | 4xE-27 A60 ECO 42W |
| SQ.511 | 130cm | 90cm | 90cm | 22cm | ✓ | 4xE-27 FLC 25W | 4xE27 LED 12W | 4xE-27 A60 ECO 42W |



Chromed pendant lamp, lampshade available in any material.

Colgante cromado y pantalla disponible en cualquier material.

Verchromte Deckenleuchte, Schirm in allen Materialien verfügbar.

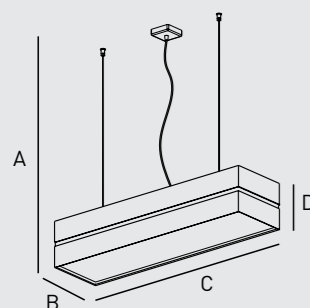
Lustre chromé, abat-jour disponible dans n'importe quel matériel.



| ref | A | B | C | D | DIF | A  | A+  | B  |
|---------------|-------|------|------|------|-----|---|--|---|
| SQ.513 | 130cm | 25cm | 70cm | 22cm | ✓ | 2xE-27 FLC 25W | 2xE27 LED 12W | 2xE-27 A60 ECO 42W |
| SQ.062 | 130cm | 25cm | 95cm | 22cm | ✓ | 4xE-27 FLC 25W | 4xE27 LED 12W | 4xE-27 A60 ECO 42W |

Chromed pendant lamp, lampshade available in any material.

Colgante cromado y pantalla disponible en cualquier material.

Verchromte Deckenleuchte, Schirm in allen Materialien verfügbar.

Lustre chromé, abat-jour disponible dans n'importe quel matériel.

MATERIALS



silver vinyl
vinilo plata
Vinyl Silber
Vinyle argenté

p 298





El Torrent

SQUARE PLA FON

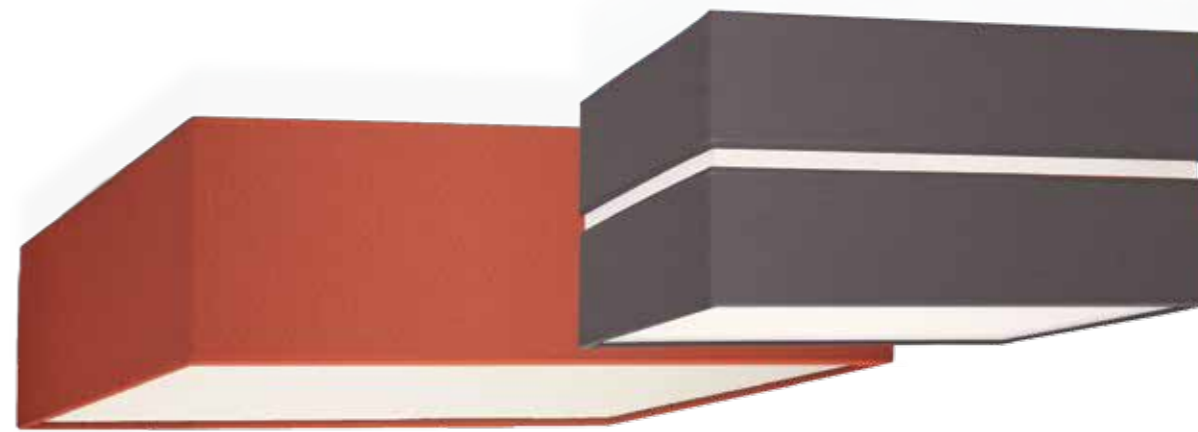



SQUARE PLAFON

El Torrent

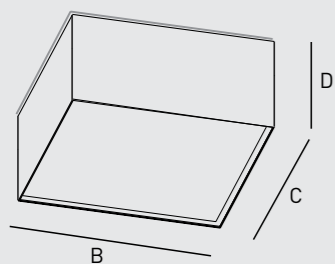
CE    IP20



| ref | A | B | C | D | DIF | A  | A+  | B  |
|---------|---|------|------|------|-----|---|--|---|
| SQP.051 | - | 40cm | 40cm | 20cm | ✓ | 2xE-27 FLC 25W | 2xE27 LED 12W | 2xE-27 A60 ECO 42W |
| SQP.052 | - | 50cm | 50cm | 20cm | ✓ | 4xE-27 FLC 25W | 4xE27 LED 12W | 4xE-27 A60 ECO 42W |
| SQP.053 | - | 70cm | 70cm | 20cm | ✓ | 4xE-27 FLC 25W | 4xE27 LED 12W | 4xE-27 A60 ECO 42W |
| SQP.510 | - | 90cm | 90cm | 20cm | ✓ | 4xE-27 FLC 25W | 4xE27 LED 12W | 4xE-27 A60 ECO 42W |
| SQP.512 | - | 25cm | 70cm | 20cm | ✓ | 2xE-27 FLC 25W | 2xE27 LED 12W | 2xE-27 A60 ECO 42W |
| SQP.054 | - | 25cm | 95cm | 20cm | ✓ | 4xE-27 FLC 25W | 4xE27 LED 12W | 4xE-27 A60 ECO 42W |



Lampshade available in any material, attached by magnets.

Pantalla disponible en cualquier material. Sujeción por imanes.

Materialien verfügbar, Halterung durch Magnete.

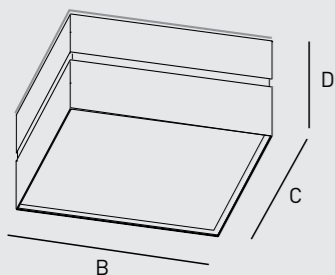
Abat-jour disponible dans n'importe quel matériel, fixation par aimants.



| ref | A | B | C | D | DIF | A  | A+  | B  |
|---------|---|------|------|------|-----|---|---|---|
| SQP.059 | - | 40cm | 40cm | 22cm | ✓ | 2xE-27 FLC 25W | 2xE27 LED 12W | 2xE-27 A60 ECO 42W |
| SQP.060 | - | 50cm | 50cm | 22cm | ✓ | 4xE-27 FLC 25W | 4xE27 LED 12W | 4xE-27 A60 ECO 42W |
| SQP.061 | - | 70cm | 70cm | 22cm | ✓ | 4xE-27 FLC 25W | 4xE27 LED 12W | 4xE-27 A60 ECO 42W |
| SQP.511 | - | 90cm | 90cm | 22cm | ✓ | 4xE-27 FLC 25W | 4xE27 LED 12W | 4xE-27 A60 ECO 42W |
| SQP.513 | - | 25cm | 70cm | 22cm | ✓ | 2xE-27 FLC 25W | 2xE27 LED 12W | 2xE-27 A60 ECO 42W |
| SQP.062 | - | 25cm | 95cm | 22cm | ✓ | 4xE-27 FLC 25W | 4xE27 LED 12W | 4xE-27 A60 ECO 42W |

Lampshade available in any material, except BBQ, BNQ, DMN, DMW. Attached by magnets.

Pantalla disponible en cualquier material, excepto BBQ, BNQ, DMN, DMW. Sujeción por imanes.

Schirm in allen Materialien verfügbar in allen Materialien, außer BBQ, BNQ, DMN, DMW. Halterung durch Magnete.

Abat-jour disponible dans n'importe quel matériel, sauf BBQ, BNQ, DMN, DMW. Fixation par aimants.



MATERIALS



cotton
tejido algodón
baumwollstoff
tissu coton

p 298



El Torrent

AROS





AROS

El Torrent

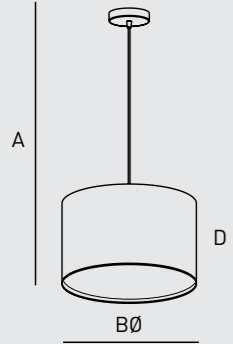
CE    IP20



| ref | A | BØ | C | D | DIF | A  | A+  | B  |
|--------|-------|------|---|------|-----|---|--|---|
| A0.117 | 130cm | 25cm | | 22cm | ✓ | 1xE-27 FLC 25W | 1xE27 LED 12W | 1xE-27 A60 ECO 42W |
| A0.118 | 130cm | 35cm | | 22cm | ✓ | 1xE-27 FLC 25W | 1xE27 LED 12W | 1xE-27 A60 ECO 42W |
| A0.119 | 130cm | 40cm | | 22cm | ✓ | 1xE-27 FLC 25W | 1xE27 LED 12W | 1xE-27 A60 ECO 42W |
| A0.120 | 130cm | 45cm | | 22cm | ✓ | 3xE-27 FLC 25W | 3xE27 LED 12W | 3xE-27 A60 ECO 42W |
| A0.121 | 130cm | 50cm | | 22cm | ✓ | 3xE-27 FLC 25W | 3xE27 LED 12W | 3xE-27 A60 ECO 42W |



All products in the AROS collection have Tech-07 support as standard but you can choose a different support from the selection on page 308. Available in any material.

Todos los AROS llevan por defecto el soporte Tech-07. Puede escoger cualquier otro soporte en la página 308. Disponible en cualquier material.

Alle AROS haben standardmäßig die Tech-07 Halterung, auf Seite 308 können Sie jegliche andere Halterung wählen. Verfügbar in allen Materialien.

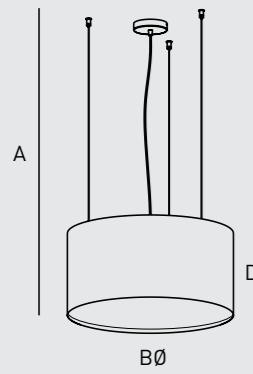
Tous les AROS présentent par défaut le support Tech-07, on peut choisir n'importe quel autre support à la page 308. Disponible dans n'importe quel matériel.



| ref | A | BØ | C | D | DIF | A  | A+  | B  |
|--------|-------|-------|---|------|-----|---|--|---|
| A0.122 | 150cm | 60cm | | 22cm | ✓ | 3xE-27 FLC 25W | 3xE27 LED 12W | 3xE-27 A60 ECO 42W |
| A0.123 | 150cm | 70cm | | 22cm | ✓ | 3xE-27 FLC 25W | 3xE27 LED 12W | 3xE-27 A60 ECO 42W |
| A0.124 | 150cm | 80cm | | 22cm | ✓ | 3xE-27 FLC 25W | 3xE27 LED 12W | 3xE-27 A60 ECO 42W |
| A0.125 | 150cm | 90cm | | 22cm | ✓ | 3xE-27 FLC 25W | 3xE27 LED 12W | 3xE-27 A60 ECO 42W |
| A0.126 | 150cm | 100cm | | 30cm | ✓ | 6xE-27 FLC 25W | 6xE27 LED 12W | 6xE-27 A60 ECO 42W |
| A0.127 | 150cm | 120cm | | 30cm | ✓ | 6xE-27 FLC 25W | 6xE27 LED 12W | 6xE-27 A60 ECO 42W |
| A0.128 | 150cm | 140cm | | 30cm | ✓ | 6xE-27 FLC 25W | 6xE27 LED 12W | 6xE-27 A60 ECO 42W |

All products in the AROS collection have Tech-07 support as standard but you can choose a different support from the selection on page 308. Available in any material.

Todos los AROS llevan por defecto el soporte Tech-07. Puede escoger cualquier otro soporte en la página 308. Disponible en cualquier material.

Alle AROS haben standardmäßig die Tech-07 Halterung, auf Seite 308 können Sie jegliche andere Halterung wählen. Verfügbar in allen Materialien.

Tous les AROS présentent par défaut le support Tech-07, on peut choisir n'importe quel autre support à la page 308. Disponible dans n'importe quel matériel.



MATERIALS



cotton
tejido algodón
baumwollstoff
tissu coton

p 298



ARROS

El Torrent





AROS 2X

El Torrent

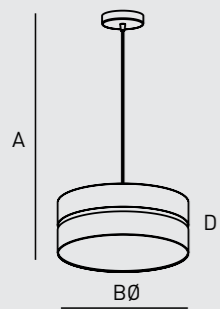
CE    IP20



| ref | A | BØ | C | D | DIF | A  | A+  | B  |
|--------|-------|------|---|------|-----|---|--|---|
| A2.132 | 130cm | 35cm | | 22cm | ✓ | 1xE27 FLC 25W | 1xE27 LED 12W | 1xE-27 A60 ECO 42W |
| A2.133 | 130cm | 45cm | | 22cm | ✓ | 3xE-27 FLC 25W | 3xE27 LED 12W | 3xE-27 A60 ECO 42W |
| A2.517 | 130cm | 50cm | | 22cm | ✓ | 3xE-27 FLC 25W | 3xE27 LED 12W | 3xE-27 A60 ECO 42W |



All products in the AROS collection have Tech-07 support as standard but you can choose a different support from the selection on page 308. Available in any material.

Todos los AROS llevan por defecto el soporte Tech-07. Puede escoger cualquier otro soporte en la página 308. Disponible en cualquier material.

Alle AROS haben standardmäßig die Tech-07 Halterung, auf Seite 308 können Sie jegliche andere Halterung wählen. Verfügbar in allen Materialien.

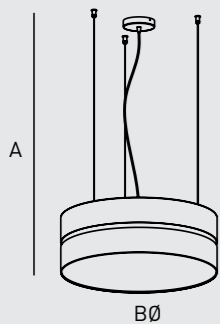
Tous les AROS présentent par défaut le support Tech-07, on peut choisir n'importe quel autre support à la page 308. Disponible dans n'importe quel matériel.



| ref | A | BØ | C | D | DIF | A  | A+  | B  |
|--------|-------|-------|---|------|-----|---|--|---|
| A2.134 | 150cm | 60cm | | 22cm | ✓ | 3xE-27 FLC 25W | 3xE27 LED 12W | 3xE-27 A60 ECO 42W |
| A2.518 | 150cm | 70cm | | 22cm | ✓ | 3xE-27 FLC 25W | 3xE27 LED 12W | 3xE-27 A60 ECO 42W |
| A2.135 | 150cm | 80cm | | 22cm | ✓ | 3xE-27 FLC 25W | 3xE27 LED 12W | 3xE-27 A60 ECO 42W |
| A2.519 | 150cm | 90cm | | 22cm | ✓ | 6xE-27 FLC 25W | 6xE27 LED 12W | 6xE-27 A60 ECO 42W |
| A2.136 | 150cm | 100cm | | 22cm | ✓ | 6xE-27 FLC 25W | 6xE27 LED 12W | 6xE-27 A60 ECO 42W |

All products in the AROS collection have Tech-07 support as standard but you can choose a different support from the selection on page 308. Available in any material.

Todos los AROS llevan por defecto el soporte Tech-07. Puede escoger cualquier otro soporte en la página 308. Disponible en cualquier material.

Alle AROS haben standardmäßig die Tech-07 Halterung, auf Seite 308 können Sie jegliche andere Halterung wählen. Verfügbar in allen Materialien.

Tous les AROS présentent par défaut le support Tech-07, on peut choisir n'importe quel autre support à la page 308. Disponible dans n'importe quel matériel.

MATERIALS



fabric
tejido
stoff
tissu

p 298



El Torrent

AROS PLA FON





AROS PLAFON

El Torrent

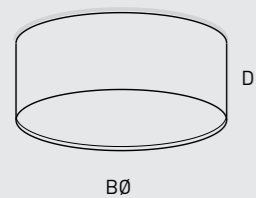
CE    IP20



| ref | A | BØ | C | D | DIF | A  | A+  | B  |
|---------|---|-------|---|------|-----|---|--|---|
| AOP.118 | - | 35cm | - | 20cm | ✓ | 2xE-27 FLC 25W | 2xE27 LED 12W | 2xE-27 A60 ECO 42W |
| AOP.119 | - | 40cm | - | 20cm | ✓ | 2xE-27 FLC 25W | 2xE27 LED 12W | 2xE-27 A60 ECO 42W |
| AOP.120 | - | 45cm | - | 20cm | ✓ | 3xE-27 FLC 25W | 3xE27 LED 12W | 3xE-27 A60 ECO 42W |
| AOP.121 | - | 50cm | - | 20cm | ✓ | 3xE-27 FLC 25W | 3xE27 LED 12W | 3xE-27 A60 ECO 42W |
| AOP.122 | - | 60cm | - | 20cm | ✓ | 3xE-27 FLC 25W | 3xE27 LED 12W | 3xE-27 A60 ECO 42W |
| AOP.123 | - | 70cm | - | 20cm | ✓ | 3xE-27 FLC 25W | 3xE27 LED 12W | 3xE-27 A60 ECO 42W |
| AOP.124 | - | 80cm | - | 20cm | ✓ | 6xE-27 FLC 25W | 6xE27 LED 12W | 6xE-27 A60 ECO 42W |
| AOP.125 | - | 90cm | - | 20cm | ✓ | 6xE-27 FLC 25W | 6xE27 LED 12W | 6xE-27 A60 ECO 42W |
| AOP.126 | - | 100cm | - | 20cm | ✓ | 6xE-27 FLC 25W | 6xE27 LED 12W | 6xE-27 A60 ECO 42W |
| AOP.127 | - | 120cm | - | 20cm | ✓ | 6xE-27 FLC 25W | 6xE27 LED 12W | 6xE-27 A60 ECO 42W |



Lampshade available in any material, attached by magnets.

Pantalla disponible en cualquier material. Sujeción por imanes.

Schirm in allen Materialien verfügbar, Halterung durch Magnete bis zu einem.

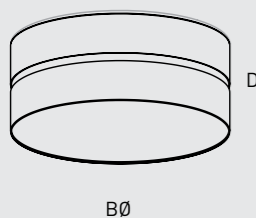
Abat-jour disponible dans n'importe quel matériel, fixation par aimants.



| ref | A | BØ | C | D | DIF | A  | A+  | B  |
|---------|---|------|---|------|-----|---|--|---|
| A2P.132 | - | 35cm | - | 22cm | ✓ | 2xE-27 FLC 25W | 2xE27 LED 12W | 2xE-27 A60 ECO 42W |
| A2P.133 | - | 45cm | - | 22cm | ✓ | 3xE-27 FLC 25W | 3xE27 LED 12W | 3xE-27 A60 ECO 42W |
| A2P.517 | - | 50cm | - | 22cm | ✓ | 3xE-27 FLC 25W | 3xE27 LED 12W | 3xE-27 A60 ECO 42W |
| A2P.134 | - | 60cm | - | 22cm | ✓ | 3xE-27 FLC 25W | 3xE27 LED 12W | 3xE-27 A60 ECO 42W |
| A2P.518 | - | 70cm | - | 22cm | ✓ | 3xE-27 FLC 25W | 3xE27 LED 12W | 3xE-27 A60 ECO 42W |
| A2P.135 | - | 80cm | - | 22cm | ✓ | 6xE-27 FLC 25W | 6xE27 LED 12W | 6xE-27 A60 ECO 42W |
| A2P.519 | - | 90cm | - | 22cm | ✓ | 6xE-27 FLC 25W | 6xE27 LED 12W | 6xE-27 A60 ECO 42W |

Lampshade available in any material, attached by magnets.

Pantalla disponible en cualquier material. Sujeción por imanes.

Schirm in allen Materialien verfügbar, Halterung durch Magnete bis zu einem.

Abat-jour disponible dans n'importe quel matériel, fixation par aimants.

MATERIALS



cotton
tejido algodón
baumwollstoff
tissu coton

p 298

PROJECT



Concejo Hospederia
Spain

p 284





AROS DOBLES

El Torrent





AROS DOBLES

El Torrent

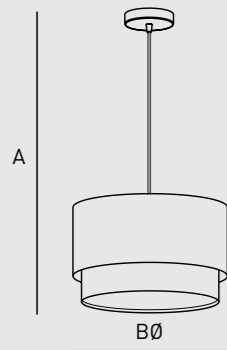
CE    IP20



| ref | A | BØ | C | D | DIF | A  | A+  | B  |
|--------|-------|------|---|------|-----|---|--|---|
| AD.400 | 130cm | 35cm | | 33cm | ✓ | 1xE-27 FLC 25W | 1xE27 LED 12W | 1xE-27 A60 ECO 42W |
| AD.401 | 130cm | 45cm | | 35cm | ✓ | 3xE-27 FLC 25W | 3xE27 LED 12W | 3xE-27 A60 ECO 42W |



All products in the AROS collection have Tech-07 support as standard but you can choose a different support from the selection on page 308. Available in any material.

Todos los AROS llevan por defecto el soporte Tech-07. Puede escoger cualquier otro soporte en la página 308. Disponible en cualquier material.

Alle AROS haben standardmäßig die Tech-07 Halterung, auf Seite 308 können Sie jegliche andere Halterung wählen. Verfügbar in allen Materialien.

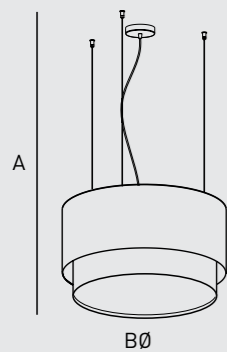
Tous les AROS présentent par défaut le support Tech-07, on peut choisir n'importe quel autre support à la page 308. Disponible dans n'importe quel matériel.



| ref | A | BØ | C | D | DIF | A  | A+  | B  |
|--------|-------|-------|---|------|-----|---|--|---|
| AD.402 | 150cm | 60cm | | 35cm | ✓ | 3xE-27 FLC 25W | 3xE27 LED 12W | 3xE-27 A60 ECO 42W |
| AD.403 | 150cm | 80cm | | 35cm | ✓ | 3xE-27 FLC 25W | 3xE27 LED 12W | 3xE-27 A60 ECO 42W |
| AD.404 | 150cm | 100cm | | 40cm | ✓ | 6xE-27 FLC 25W | 6xE27 LED 12W | 6xE-27 A60 ECO 42W |
| AD.405 | 150cm | 120cm | | 40cm | ✓ | 6xE-27 FLC 25W | 6xE27 LED 12W | 6xE-27 A60 ECO 42W |

All products in the AROS collection have Tech-07 support as standard but you can choose a different support from the selection on page 308. Available in any material.

Todos los AROS llevan por defecto el soporte Tech-07. Puede escoger cualquier otro soporte en la página 308. Disponible en cualquier material.

Alle AROS haben standardmäßig die Tech-07 Halterung, auf Seite 308 können Sie jegliche andere Halterung wählen. Verfügbar in allen Materialien.

Tous les AROS présentent par défaut le support Tech-07, on peut choisir n'importe quel autre support à la page 308. Disponible dans n'importe quel matériel.



MATERIALS



varnished wood
madera laminada
lamelliertes Holz
bois stratifié

p 298

PROJECT



Japanese restaurant
Ukraine

p 285



El Torrent

AROS TRIPLES





AROS TRIPLES

El Torrent

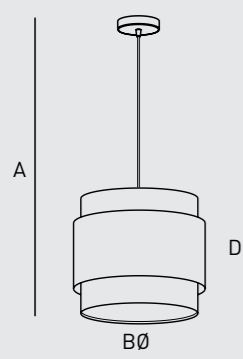
CE    IP20



| ref | A | BØ | C | D | DIF | A  | A+  | B  |
|--------|-------|------|---|------|-----|---|--|---|
| AT.406 | 130cm | 35cm | | 34cm | ✓ | 1xE-27 FLC 25W | 1xE27 LED 12W | 1xE-27 A60 ECO 42W |
| AT.407 | 130cm | 45cm | | 35cm | ✓ | 3xE-27 FLC 25W | 3xE27 LED 12W | 3xE-27 A60 ECO 42W |



All products in the AROS collection have Tech-07 support as standard but you can choose a different support from the selection on page 308. Available in any material.

Todos los AROS llevan por defecto el soporte Tech-07. Puede escoger cualquier otro soporte en la página 308. Disponible en cualquier material.

Alle AROS haben standardmäßig die Tech-07 Halterung, auf Seite 308 können Sie jegliche andere Halterung wählen. Verfügbar in allen Materialien.

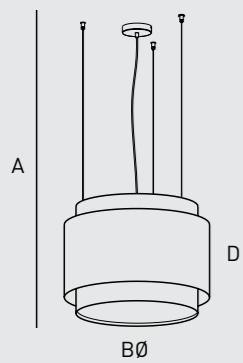
Tous les AROS présentent par défaut le support Tech-07, on peut choisir n'importe quel autre support à la page 308. Disponible dans n'importe quel matériel.



| ref | A | BØ | C | D | DIF | A  | A+  | B  |
|--------|-------|-------|---|------|-----|---|--|---|
| AT.408 | 150cm | 60cm | | 45cm | ✓ | 3xE-27 FLC 25W | 3xE27 LED 12W | 3xE-27 A60 ECO 42W |
| AT.530 | 150cm | 80cm | | 55cm | ✓ | 6xE-27 FLC 25W | 6xE27 LED 12W | 6xE-27 A60 ECO 42W |
| AT.531 | 150cm | 100cm | | 55cm | ✓ | 6xE-27 FLC 25W | 6xE27 LED 12W | 6xE-27 A60 ECO 42W |
| AT.532 | 150cm | 120cm | | 55cm | ✓ | 6xE-27 FLC 25W | 6xE27 LED 12W | 6xE-27 A60 ECO 42W |

All products in the AROS collection have Tech-07 support as standard but you can choose a different support from the selection on page 308. Available in any material.

Todos los AROS llevan por defecto el soporte Tech-07. Puede escoger cualquier otro soporte en la página 308. Disponible en cualquier material.

Alle AROS haben standardmäßig die Tech-07 Halterung, auf Seite 308 können Sie jegliche andere Halterung wählen. Verfügbar in allen Materialien.

Tous les AROS présentent par défaut le support Tech-07, on peut choisir n'importe quel autre support à la page 308. Disponible dans n'importe quel matériel.



MATERIALS



cotton + eco-leather
tejido algodón + ecopiel
baumwollstoff + ecopiel
tissu coton + éco-cuir
p 298

PROJECT



Café Delimarché
Finland
p 284



El Torrent

TUBS



TUBS

El Torrent

CE V IP20

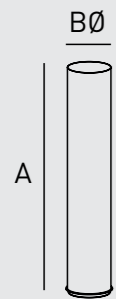

| ref | A | BØ | C | D | DIF | A | A+ | B |
|---------------|-------|------|---|---|-----|----------------|---------------|--------------------|
| TB.095 | 150cm | 28cm | | | | 6xE-27 FLC 25W | 6xE27 LED 12W | 6xE-27 A60 ECO 42W |



Floor lamp with chromed base, lampshade available in any material.

Modelo pie con base cromada y pantalla disponible en cualquier material.

Steh, verchromte Basis, Schirm verfügbar in allen Materialien.

Modèle pied, base chromée, abat-jour disponible dans n'importe quel matériel.

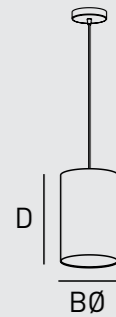

| ref | A | BØ | C | D | DIF | A | A+ | B |
|---------------|-------|------|---|------|-----|----------------|---------------|--------------------|
| TB.001 | 130cm | 12cm | | 25cm | | 1xE-27 FLC 25W | 1xE27 LED 12W | 1xE-27 A60 ECO 42W |
| TB.002 | 130cm | 18cm | | 25cm | | 1xE-27 FLC 25W | 1xE27 LED 12W | 1xE-27 A60 ECO 42W |
| TB.003 | 130cm | 20cm | | 30cm | | 1xE-27 FLC 25W | 1xE27 LED 12W | 1xE-27 A60 ECO 42W |
| TB.004 | 130cm | 25cm | | 50cm | | 1xE-27 FLC 25W | 1xE27 LED 12W | 1xE-27 A60 ECO 42W |



All products in the TUBS collection have Tech-07 support as standard but you can choose a different support from the selection on page 308. Available in any material.

Todos los TUBS llevan por defecto el soporte Tech-07. Puede escoger cualquier otro soporte en la página 308. Disponible en cualquier material.

Alle TUBS haben standardmäßig die Tech-07 Halterung, auf Seite 308 können Sie jegliche andere Halterung wählen. Verfügbar in allen Materialien.

Tous les TUBS présentent par défaut le support Tech-07, on peut choisir n'importe quel autre support à la page 308. Disponible dans n'importe quel matériel.

MATERIALS



cotton
tejido algodón
baumwollstoff
tissu coton

p 298

PROJECT



Castell Sant Gregori
Spain

p 285



TUBS

El Torrent

CE    IP20

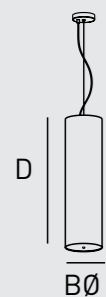

| ref | A | BØ | C | D | DIF | A |
|------------------|---|------|---|-------|-----|----------|
| TB.005.11 | | 20cm | | 70cm | ✓ | 2xT5 24W |
| TB.006.11 | | 20cm | | 100cm | ✓ | 2xT5 39W |

All products in the TUBS collection have Tech-07 support as standard but you can choose a different support from the selection on page 308. Available in any material.

Todos los TUBS llevan por defecto el soporte Tech-07. Puede escoger cualquier otro soporte en la página 308. Disponible en cualquier material.

Alle TUBS haben standardmäßig die Tech-07 Halterung, auf Seite 308 können Sie jegliche andere Halterung wählen. Verfügbar in allen Materialien.

Tous les TUBS présentent par défaut le support Tech-07, on peut choisir n'importe quel autre support à la page 308. Disponible dans n'importe quel matériel.

MATERIALS



crystal pvc / fabric
pvc cristal/ tejido
glas pvc / stoff
pvc verre/ tissu

p 298



TUBS

El Torrent

CE    IP20

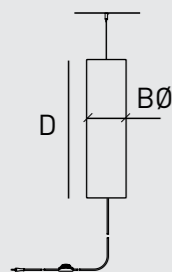

| ref | A | BØ | C | D | DIF | A |
|-----------|------|----|---|-------|-----|----------|
| TB.007.11 | 20cm | | | 70cm | ✓ | 2xT5 24W |
| TB.008.11 | 20cm | | | 100cm | ✓ | 2xT5 39W |

Pendant lamp with lower cable for wall socket, available in any material.

Colgante con toma de corriente inferior, disponible en cualquier material.

Hängelampe mit Stromanschluss unten, in allen Materialien erhältlich.

Suspension à alimentation électrique par le bas, disponible dans tous les matériaux.

MATERIALS



crystal pvc / fabric
pvc cristal / tejido
glas pvc / stoff
pvc verre / tissu

p 298





CONET

El Torrent





CONET

El Torrent

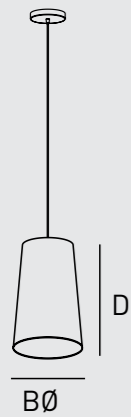
CE    IP20



| ref | A | BØ | C | D | DIF | A  | A+  | B  |
|--------|---|------|---|------|-----|---|--|---|
| CN.001 | | 20cm | | 31cm | | 1xE-27 FLC 25W | 1xE27 LED 12W | 1xE-27 A60 ECO 42W |
| CN.002 | | 30cm | | 45cm | | 1xE-27 FLC 25W | 1xE27 LED 12W | 1xE-27 A60 ECO 42W |
| CN.003 | | 40cm | | 60cm | | 1xE-27 FLC 25W | 1xE27 LED 12W | 1xE-27 A60 ECO 42W |

All products in the TUBS collection have Tech-07 support as standard but you can choose a different support from the selection on page 308. Available in any material, except BBQ, BNQ, DMN, DMW

Todos los TUBS llevan por defecto el soporte Tech-07. Puede escoger cualquier otro soporte en la página 308. Disponible en cualquier material, excepto BBQ, BNQ, DMN, DMW

Alle TUBS haben standardmäßig die Tech-07 Halterung, auf Seite 308 können Sie jegliche andere Halterung wählen. Verfügbar in allen Materialien, außer BBQ, BNQ, DMN, DMW

Tous les TUBS présentent par défaut le support Tech-07, on peut choisir n'importe quel autre support à la page 308. Disponible dans n'importe quel matériel, sauf BBQ, BNQ, DMN, DMW



MATERIALS



cotton
tejido algodón
baumwollstoff
tissu coton
p 298

PROJECT



Castell Sant Gregori
Spain
p 285



1



3



4



7

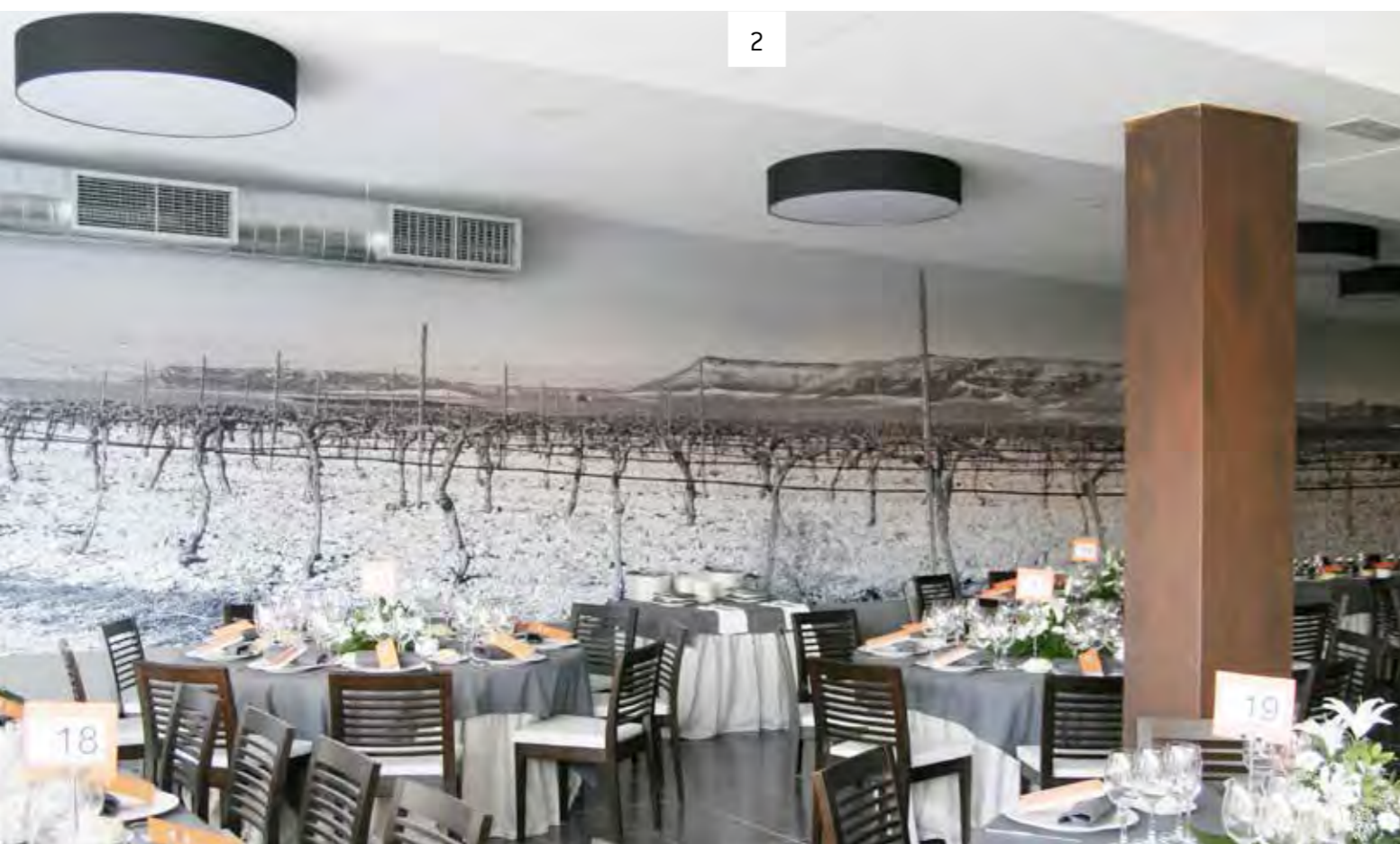

2



5

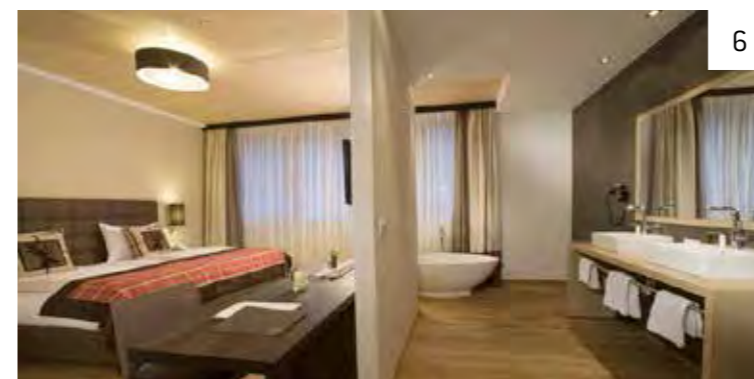

6



8

1 3

Café Delimarché
Finland

Modelo
AROS TRIPLE / AROS 2X

2

Concejo Hospederia
Spain

Modelo
PLAFONES

4

Artepan
Spain

Modelo
AROS/EVA

5

Japanese Restaurant
Ukraine

Modelo
AROS DOBLES

6

Das Kronthaler Hotel
Austria

Modelo
AROS

7 8

Castell Sant Gregori
Spain

Modelo
CONETS / TUBS

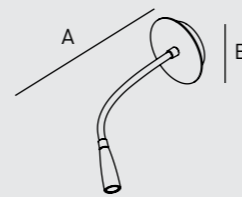

| ref | A | BØ | C | D | A+ |
|--------|------|------|---|---|--------------------------|
| AP.520 | 30cm | 10cm | | | 1xLEDs 1,5w 100lm 6300°K |

Nickel plated body, cable with 1,5W LED.

Base niquelada y flexo con led de 1,5W.

Vernickelter Körper, Schlauchlampe mit 1,5W-LED.

Corps nickelé, tige à led de 1,5W.

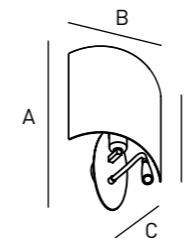

| ref | A | B | C | D | A | A+ | B |
|--------|------|------|------|------|------------------------------|----------------------------|-----------------------------|
| AP.521 | 38cm | 22cm | 25cm | 25cm | 1xE-27 FLC 21w + 1xLEDs 1,5w | 1XE27 LED 5W + 1xLEDs 1,5w | 1XE27 ECO 24W + 1xLEDs 1,5w |

Nickel plated body, lampshade available in any material. Cable with 1,5W LED

Base en niquel y pantalla disponible en cualquier material. Flexo con led de 1,5W.

Vernickelter Körper, Schirm in allen Materialien verfügbar. Schlauchlampe mit 1,5W-LED.

Corps nickelé, abat-jour disponible dans n'importe quel matériel. Tige à led de 1,5W.



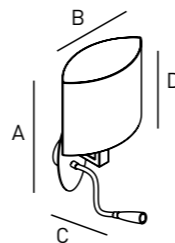

| ref | A | B | C | D | A | A+ | B |
|--------|------|------|------|------|---------------------------------|-------------------------------|--------------------------------|
| AP.523 | 40cm | 25cm | 30cm | 20cm | 1xE-27 FLC 21w + 1xLEDs 1,5w | 1XE27 LED 5W + 1xLEDs 1,5w | 1XE27 ECO 24W + 1xLEDs 1,5w |

Nickel plated body, lampshade available in any material.

Base en niquel y pantalla disponible en cualquier material.

Vernickelter Körper, Schirm in allen Materialien verfügbar.

Corps nickelé, abat-jour disponible dans n'importe quel matériel.

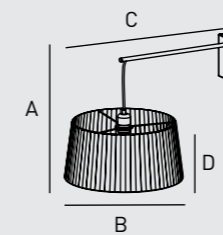

| ref | A | BØ | C | D | A | A+ | B |
|--------|------|------|------|------|----------------|--------------|---------------|
| AP.524 | 40cm | 40cm | 60cm | 20cm | 1xE-27 FLC 21w | 1XE27 LED 5W | 1XE27 ECO 24W |

Chromed body, lampshade available in any material.

Base cromada y pantalla disponible en cualquier material.

Verchromter Körper, Schirm in allen Materialien verfügbar.

Corps chromé, abat-jour disponible dans n'importe quel matériel.





AP.525



AP.526

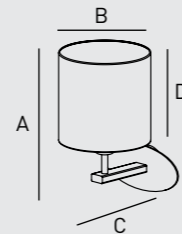
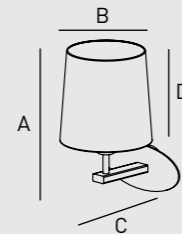

| ref | A | B0 | C | D | A | A+ | B |
|--------|------|------|------|------|----------------|--------------|---------------|
| AP.525 | 30cm | 20cm | 22cm | 20cm | 1xE-27 FLC 21W | 1XE27 LED 5W | 1XE27 ECP 24W |
| AP.526 | 28cm | 18cm | 21cm | 18cm | 1xE-27 FLC 21W | 1XE27 LED 5W | 1XE27 ECP 24W |

Chromed body, lampshade available in any material.

Base en niquel y pantalla disponible en cualquier material.

Verchromter Körper, Schirm in allen Materialien verfügbar.

Corps chromé, abat-jour disponible dans n'importe quel matériel.

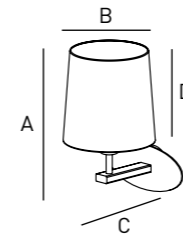

AP.527

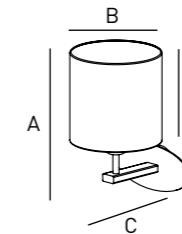

AP.528

| ref | A | B0 | C | D | A | A+ | B |
|--------|------|------|------|------|----------------|--------------|---------------|
| AP.527 | 30cm | 20cm | 22cm | 20cm | 1xE-27 FLC 21W | 1XE27 LED 5W | 1XE27 ECP 24W |
| AP.528 | 28cm | 18cm | 21cm | 18cm | 1xE-27 FLC 21W | 1XE27 LED 5W | 1XE27 ECP 24W |

Gold body, lampshade available in any material.

Base oro mate y pantalla disponible en cualquier material.

Körper Gold, Schirm in allen Materialien verfügbar.

Corps or, abat-jour disponible dans n'importe quel matériel.

AP.527



AP.528



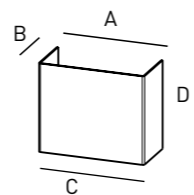

| ref | A | B | C | D | A | A+ |
|---------------|------|------|------|------|----------------|----------------|
| WL.199 | 30cm | 14cm | 30cm | 25cm | 1xE-27 FLC 21W | 1xE-27 LED 10w |
| WL.287 | 20cm | 12cm | 20cm | 30cm | 1xE-27 FLC 21W | 1xE-27 LED 10w |
| WL.223 | 18cm | 14cm | 18cm | 40cm | 1xE-27 FLC 21W | 1xE-27 LED 10w |

Lampshade available in any material.

Pantalla disponible en cualquier material.

Schirm in allen Materialien verfügbar.

Abat-jour disponible dans n'importe quel matériel.

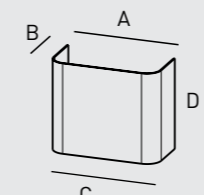

| ref | A | B | C | D | A | A+ |
|---------------|-------|------|-------|------|----------------|----------------|
| WL.414 | 30cm | 14cm | 30cm | 25cm | 1xE-27 FLC 21W | 1xE-27 LED 10w |
| WL.416 | 60cm | 14cm | 60cm | 25cm | 2xE-27 FLC 21W | 2xE-27 LED 10w |
| WL.417 | 90cm | 16cm | 90cm | 25cm | 4xE-27 FLC 21W | 4xE-27 LED 10w |
| WL.418 | 120cm | 16cm | 120cm | 25cm | 5xE-27 FLC 21W | 5xE-27 LED 10w |

Lampshade available in any material.

Pantalla disponible en cualquier material.

Schirm in allen Materialien verfügbar.

Abat-jour disponible dans n'importe quel matériel.



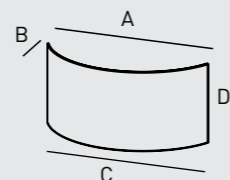

| ref | A | B | C | D | A | A+ |
|--------|------|------|------|------|----------------|----------------|
| WL.286 | 22cm | 12cm | 22cm | 25cm | 1xE-27 FLC 21W | 1xE-27 LED 10w |
| WL.175 | 30cm | 15cm | 30cm | 25cm | 1xE-27 FLC 21W | 1xE-27 LED 10w |
| WL.228 | 30cm | 15cm | 30cm | 60cm | 2xE-27 FLC 21W | 2xE-27 LED 10w |
| WL.016 | 45cm | 14cm | 45cm | 22cm | 1xE-27 FLC 21W | 1xE-27 LED 10w |
| WL.017 | 70cm | 12cm | 70cm | 26cm | 2xE-27 FLC 21W | 2xE-27 LED 10w |

Lampshade available in any material.

Pantalla disponible en cualquier material.

Schirm in allen Materialien verfügbar.

Abat-jour disponible dans n'importe quel matériel.

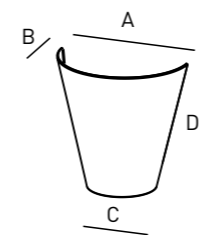

| ref | A | B | C | D | A | A+ |
|--------|------|------|------|------|----------------|----------------|
| WL.174 | 30cm | 15cm | 15cm | 30cm | 1xE-27 FLC 21W | 1xE-27 LED 10w |

Lampshade available in any material.

Pantalla disponible en cualquier material.

Schirm in allen Materialien verfügbar.

Abat-jour disponible dans n'importe quel matériel.



CUSTOMI- ZATION

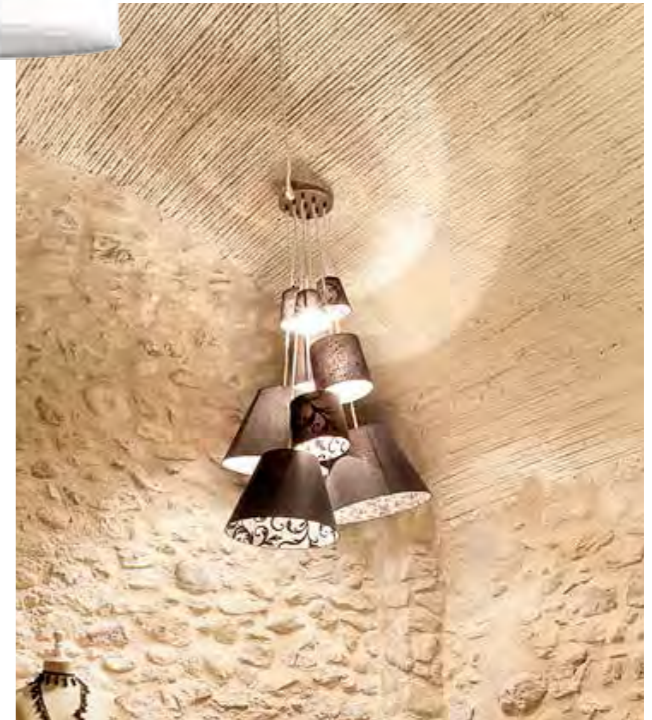

Customisation of any kind of lamp or lampshade, made to measure. Logos, photographs or special designs.

Personalizaciones de cualquier tipo de lampara o pantalla a medida. Logos, fotografias o diseños especiales.

Alle Arten von Personalisierungen von Lampen oder Schirmen nach Maß. Logos, Fotos oder spezifisches Design.

Personnalisations de tout type de lampe ou abat-jour sur mesure. Logos, photos et créations exclusives.

A - GROUP



AAN



AAT



ANG



AOR

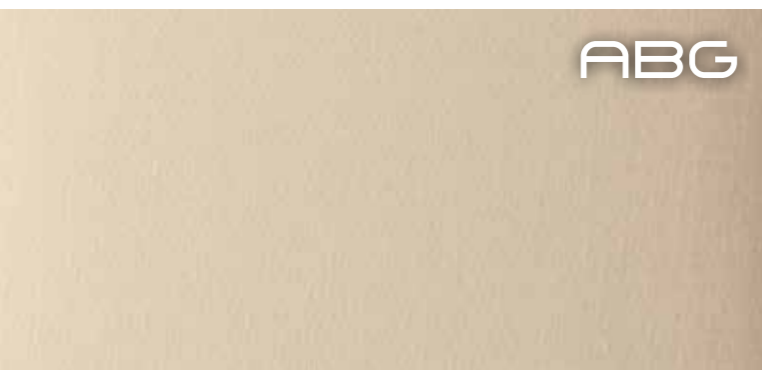

ABG



ALB



APB

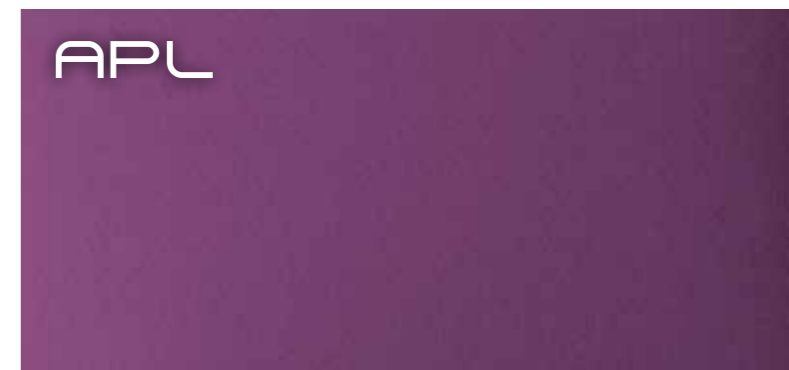

APL



AVA

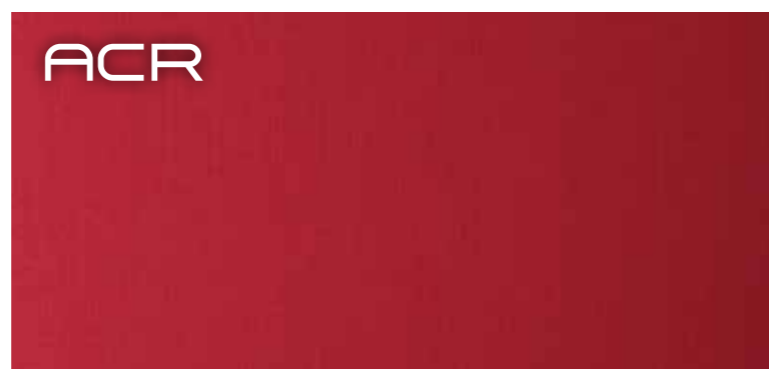

ACR

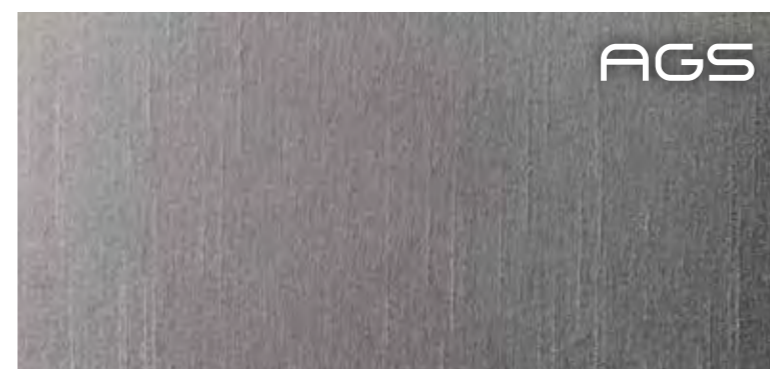

AGS

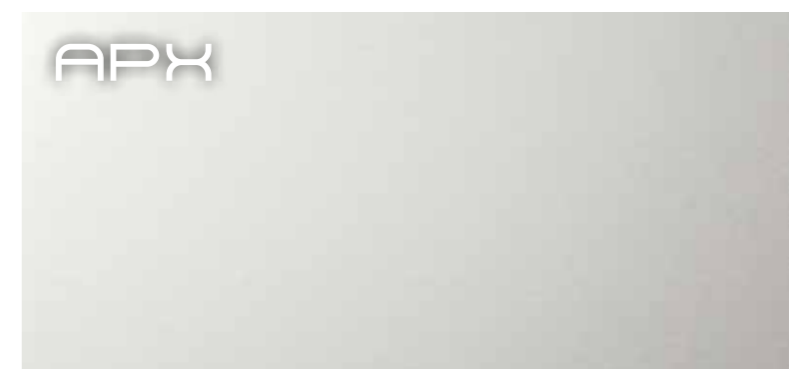

APX

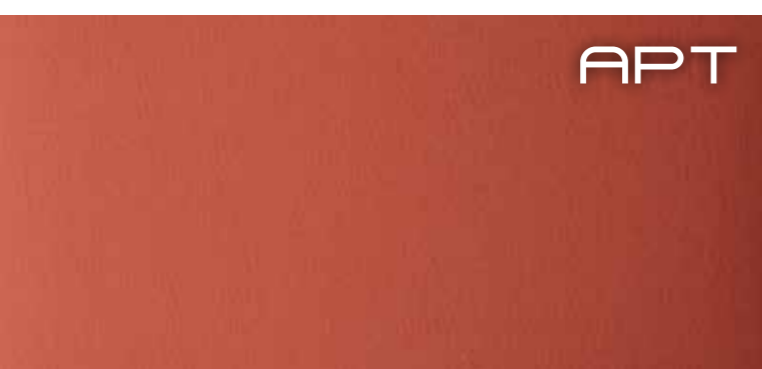

APT



AGT



ACA

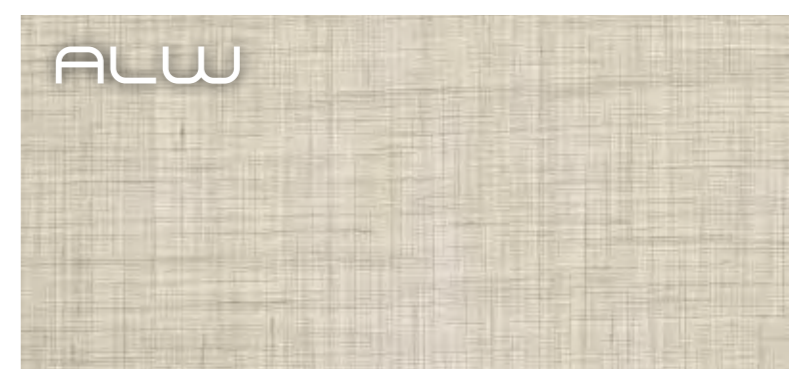

ALW

AAN

cotton
tejido algodón
baumwollstoff
tissu coton

AAT

cotton
tejido algodón
baumwollstoff
tissu coton

ABG

shiny cotton
algodon brillante
leuchtend baumwollen
cotton allumé

ALB

cotton
tejido algodón
baumwollstoff
tissu coton

ANG

cotton
tejido algodón
baumwollstoff
tissu coton

AOR

cotton
tejido algodón
baumwollstoff
tissu coton

APB

cotton
tejido algodón
baumwollstoff
tissu coton

APL

cotton
tejido algodón
baumwollstoff
tissu coton

AVA

cotton
tejido algodón
baumwollstoff
tissu coton

ACR

cotton
tejido algodón
baumwollstoff
tissu coton

APT

cotton
tejido algodón
baumwollstoff
tissu coton

AGT

shiny cotton
algodon brillante
leuchtend baumwollen
cotton allumé

AGS

shiny cotton
algodon brillante
leuchtend baumwollen
cotton allumé

APX

washable shiny cotton
algodon brillante lavable
waschbarer leuchtend baumwollen
cotton allumé lavable

ACA

linen
tejido lino
leinenstoff
tissu lin

ALW

linen
tejido lino
leinenstoff
tissu lin

B - GROUP



BAW



BAR



BCR

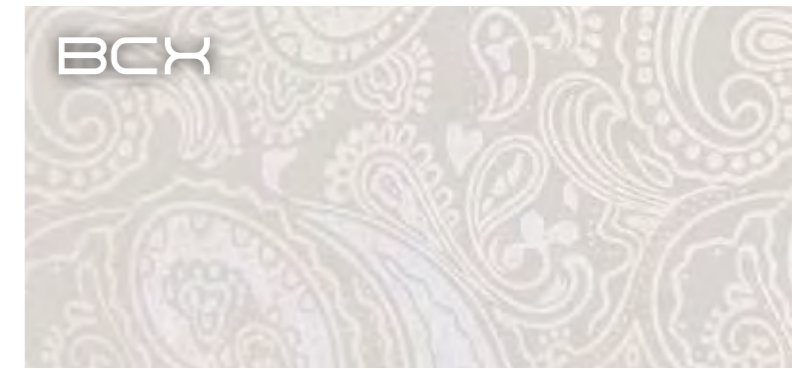

BCX



BBB



BBS



BFO



BNB

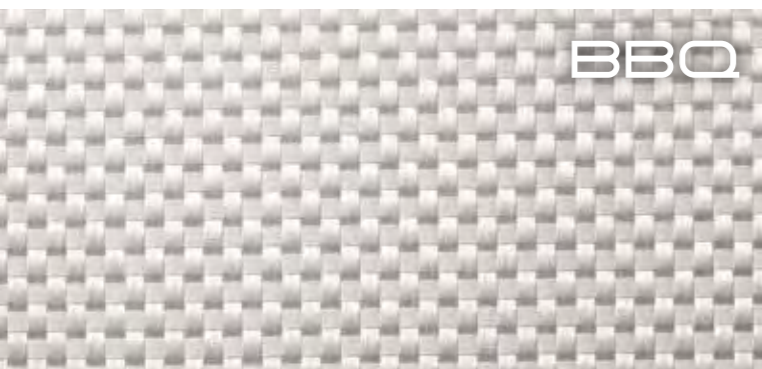

BBO

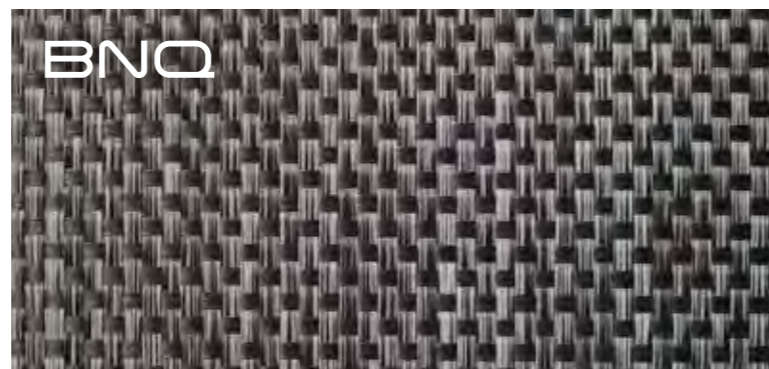

BNO



BHB

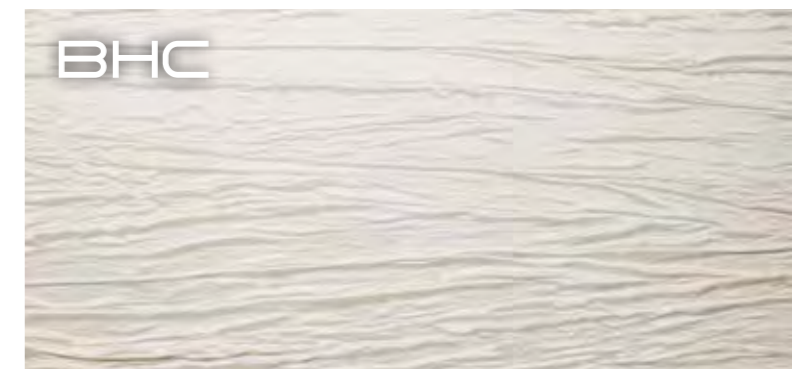

BHC



BCA



BCG

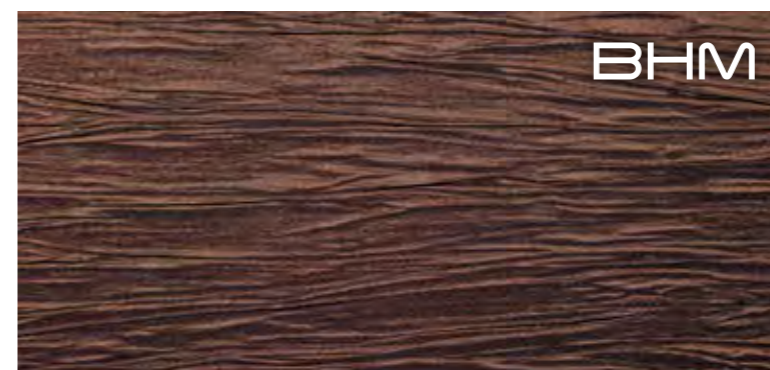

BHM



BHS

BAW

semi-transparent fabric
tejido semi-transparente
Halbdurchscheinendes Gewebe
tissu semi-transparente

BAR

semi-transparent fabric
tejido semi-transparente
Halbdurchscheinendes Gewebe
tissu semi-transparente

BBB

embroidered organza
organza bordada
bestickter Organza
organza brodée

BBS

embroidered organza
organza bordada
bestickter Organza
organza brodée

BCR

eco-leather
ecopiel
ecopiel
éco-cuir

BCX

Wallpaper
Papier pared
Tapeten
Papier peint

BFO

vinyl
vinilo
vinyl
vinyle

BNB

fabric out., copper polyester in.
ext. tejido, int. poliéster cobre.
Außen Gewebe, innen Kupfer-Polyester.
ext. tissu, int. polyester cuivre.

BBO

texplast
texplast
texplast
texplast

BNO

texplast
texplast
texplast
texplast

BCA

eco-leather
ecopiel
ecopiel
éco-cuir

BCG

vinyl
vinilo
vinyl
vinyle

BHB

taffeta
tafetán
taft
taffetas

BHC

taffeta
tafetán
taft
taffetas

BHM

taffeta
tafetán
taft
taffetas

BHS

taffeta
tafetán
taft
taffetas

B - GROUP

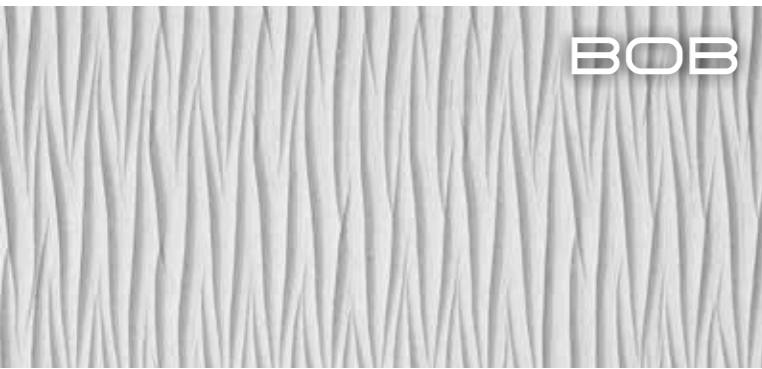

BOB



BOG



BSB



BSM



BTS



BTG

BOB

organzie
organza
organza
organza

BTS

polyester fabric
tejido poliéster
polyesterstoff
tissu polyester

BOG

organzie
organza
organza
organza

BTG

polyester fabric
tejido poliéster
polyesterstoff
tissu polyester

BSB

wild silk
seda salvaje
wilde Seide
soie sauvage

BSM

wild silk
seda salvaje
wilde Seide
soie sauvage

C - GROUP



CBD



CWH



CRU



CMR



COR



CGI

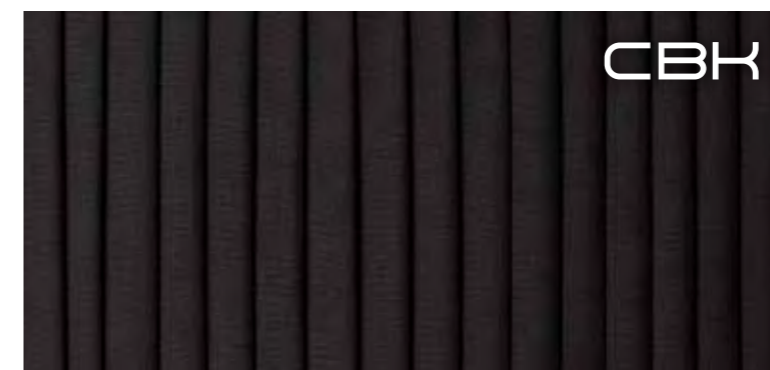

CBK

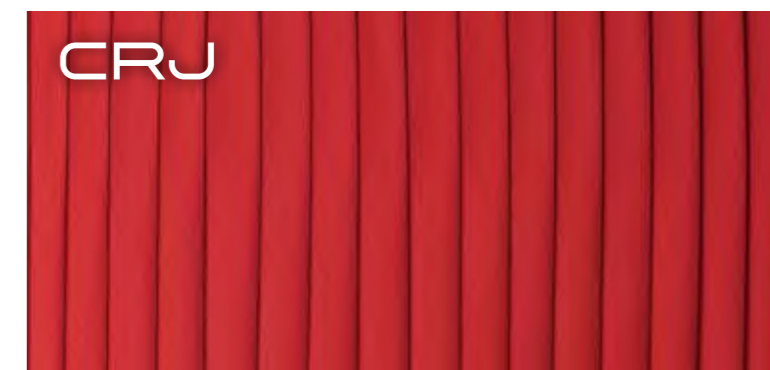

CRJ

CBD

pleated fabrics
cinta plisada
plissiertes Band
ruban plissé

COR

pleated fabrics
cinta plisada
plissiertes Band
ruban plissé

CWH

pleated fabrics
cinta plisada
plissiertes Band
ruban plissé

CGI

pleated fabrics
cinta plisada
plissiertes Band
ruban plissé

CRU

pleated fabrics
cinta plisada
plissiertes Band
ruban plissé

CBK

pleated fabrics
cinta plisada
plissiertes Band
ruban plissé

CMR

pleated fabrics
cinta plisada
plissiertes Band
ruban plissé

CRJ

pleated fabrics
cinta plisada
plissiertes Band
ruban plissé

C - GROUP



CBDX



CWHX



CRUX



CMRX

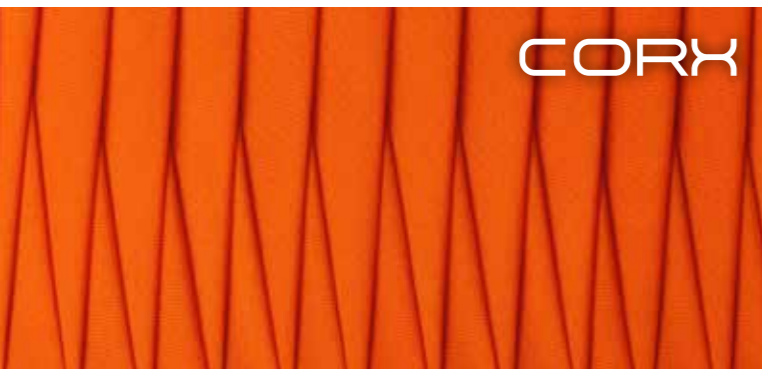

CORX

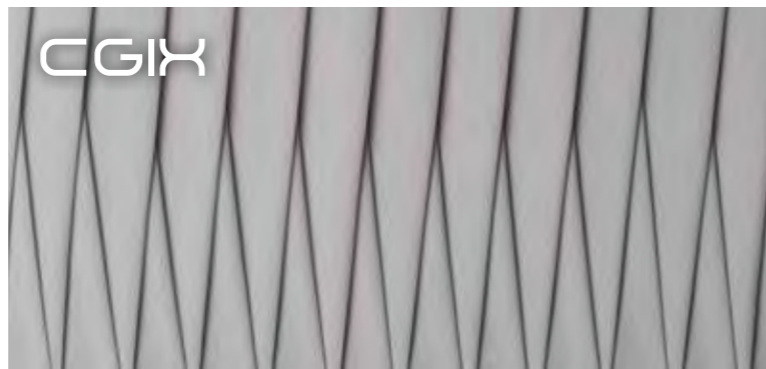

CGIX

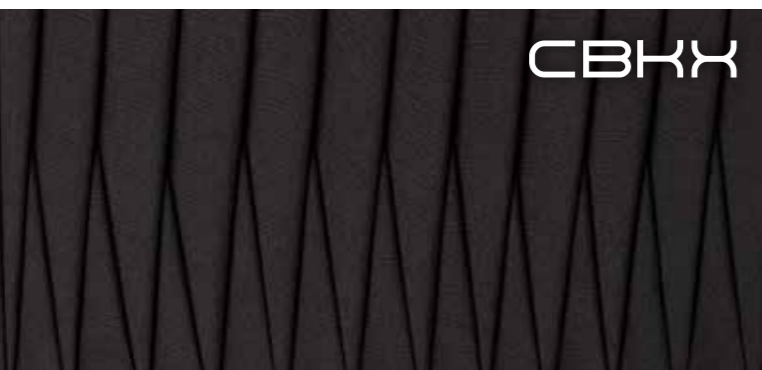

CBKX



CRJX

CBDX

cross-pleated band
cinta plisada cruzada
Über Kreuz plissiertes Band
bande plissée croisée

CWHX

cross-pleated band
cinta plisada cruzada
Über Kreuz plissiertes Band
bande plissée croisée

CRUX

cross-pleated band
cinta plisada cruzada
Über Kreuz plissiertes Band
bande plissée croisée

CMRX

cross-pleated band
cinta plisada cruzada
Über Kreuz plissiertes Band
bande plissée croisée

CORX

cross-pleated band
cinta plisada cruzada
Über Kreuz plissiertes Band
bande plissée croisée

CGIX

cross-pleated band
cinta plisada cruzada
Über Kreuz plissiertes Band
bande plissée croisée

CBKX

cross-pleated band
cinta plisada cruzada
Über Kreuz plissiertes Band
bande plissée croisée

CRJX

cross-pleated band
cinta plisada cruzada
Über Kreuz plissiertes Band
bande plissée croisée

D - GROUP



DAM



DBO



DCB



DVP



DDG



DDN



DKG



DKS

DAM

fabric
tejido
stoff
tissu

DBO

iridescent silver polyester
poliéster plateado iridiscente
polyester argenté lustré
Irisierendes, silbernes Polyester

DCB

PVC glass
cristal PVC
crystal PVC
verre PVC

DVP

vinyl
vinilo
vinyl
vinyle

DDG

embroidered organza
organza bordada
bestickter Organza
organza brodé

DDN

embroidered organza
organza bordada
bestickter Organza
organza brodé

DKG

gold vinyl
vinilo oro
Vinyle doré
Vinyl Gold

DKS

silver vinyl
vinilo plata
Vinyle argenté
Vinyl Silber

D - GROUP



DMN



DMW



DVC

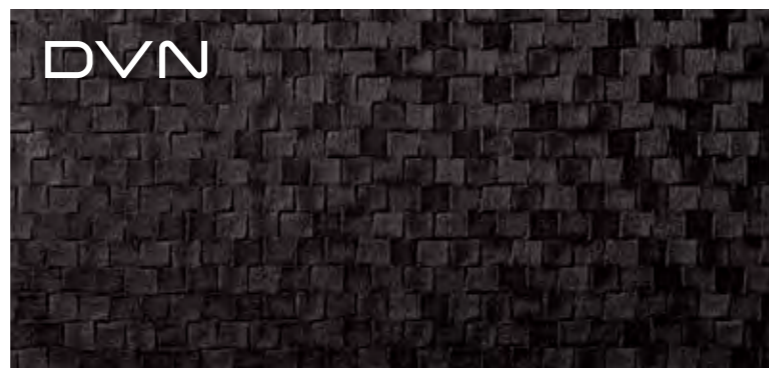

DVN



DYB

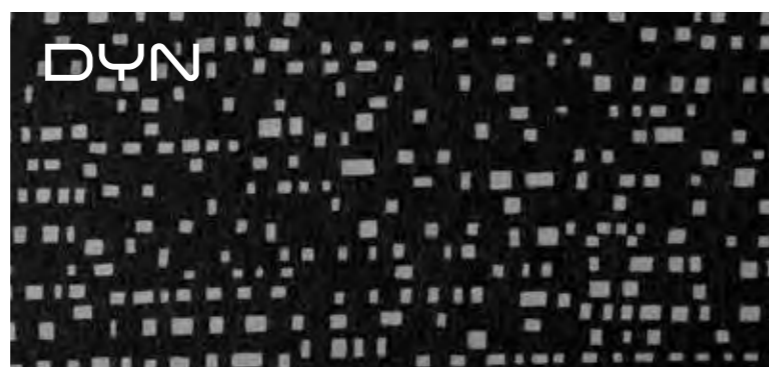

DYN



DGB

DMN

varnished wood
madera laminada
lamelliertes Holz
bois stratifié

DYB

fabric
tejido
stoff
tissu

DMW

varnished wood
madera laminada
lamelliertes Holz
bois stratifié

DYN

fabric
tejido
stoff
tissu

DVC

vinyl
vinilo
vinyl
vinyle

DGB

embroidered organza
organza bordada
bestickter Organza
organza brodé

DVN

vinyl
vinilo
vinyl
vinyle

SPECIALS



QB



QG

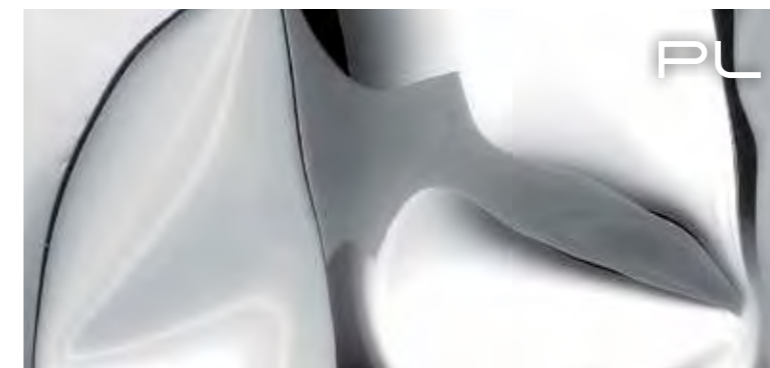

PL



ZU



CES

QB

organza
organza
organza
organza

Modelo
TRUDY

QG

organza
organza
organza
organza

Modelo
TRUDY

PL

polyester
poliester
polyester
polyester

Modelo
BERTA

ZU

black mesh
rejilla negra
schwarzes Netz
résille noire

Modelo
NEX

CES

Acrylic elastic band
Cinta malla elástica
Elastisches Maschengewebeband
Bande maille élastique

Modelo
GEMMA

LIGHT SUSPENSION KITS / CABLES



TECH 01

Brown square support.
Cuadrado marrón.
Quadratisch Braun.
Carré marron.



TECH 02

Grey square support.
Cuadrado gris.
Quadratisch Grau.
Carré gris.



TECH 04

Chromed square support.
Cuadrado cromo.
Quadratisch Chrom.
Carré chrome.



TECH 10

Chromed round support, steel cable.
Cuadrado cromo y cable de acero.
Quadratisch Chrom, Stahlkabel.
Carré chrome, câble en acier.



TECH 19

Grey square support, 25 cm rod.
Cuadrado gris, vástago de 25cm.
Quadratisch Grau, Schaft 25cm.
Carré gris, tige 25 cm.



TECH 20

Chromed square support, 25cm rod.
Cuadrado cromo, vástago de 25cm.
Quadratisch Chrom, Schaft 25cm.
Carré chrome, tige 25 cm.



TECH 21

Nickel plated square support, 25cm rod.
Cuadrado níquel, vástago de 25cm.
Quadratisch Nickel, Schaft 25cm.
Carré nickel, tige 25 cm.



TECH 16

Grey round support, 25 cm rod.
Redondo Gris, vástago de 25cm.
Rund Grau, Schaft 25cm.
Rond gris, tige 25 cm.



TECH 17

Chromed round support, 25cm rod.
Redondo cromo, vástago de 25cm.
Rund Chrom, Schaft 25cm.
Rond chrome, tige 25 cm.



TECH 18

Nickel plated round support, 25cm rod.
Redondo níquel, vástago 25cm.
Rund Nickel, Schaft 25cm.
Rond nickel, tige 25 cm.



TECH 05

Brown round support.
Redondo marrón.
Rund Braun.
Rond marron.



TECH 06

Grey round support.
Redondo gris.
Rund Grau.
Rond gris.



TECH 07

Chromed round support.
Redondo cromo.
Rund Chrom.
Rond chrome.



TECH 08

Nickel plated round support.
Redondo níquel.
Rund Nickel.
Rond nickel.



TECH 28

Gold round support.
Redondo Oro.
Rund Gold.
Rond or.



TECH 27

Black round support.
Redondo negro.
Rund Schwarz.
Rond noir.



TECH 30

White round support.
Redondo blanco.
Rund weiß.
Rond blanc.



TECH 11

Nickel plated round support, steel cable.
Redondo níquel y cable de acero.
Rund Nickel, Stahlkabel.
Rond nickel, câble en acier.



TECH 09

Chromed round support, steel cable.
Redondo cromo y cable de acero.
Rund Chrom, Stahlkabel.
Rond chrome, câble en acier.



TECH 23

Chromed round support, 3 steel cables.
Redondo cromo, 3 cables de acero.
Rund Chrom, 3 Stahlkabel.
Rond chrome, 3 câbles en acier.



TECH 25

Chromed round support, 2 transparent cables.
Redondo cromo, 2 cables transparentes.
Rund Chrom, 2 transparente Kabel.
Rond chrome, 2 câbles transparent.



TECH 26

Chromed round support, 3 transparent cables.
Redondo cromo, 3 cables transparentes.
Rund Chrom, 3 transparente Kabel.
Rond chrome, 3 câbles transparent.



TECH 14

Gold S/C round support.
Redondo S/C Oro.
Rund S/C Gold.
Rond S/C or.



TECH 12

Chromed S/C round support.
Redondo S/C cromo.
Rund S/C Chrom.
Rond S/C chrome.

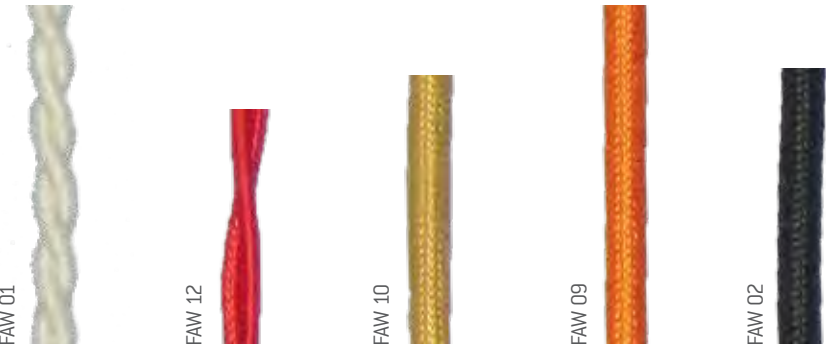

FAW 01

FAW 12

FAW 10

FAW 09

FAW 02

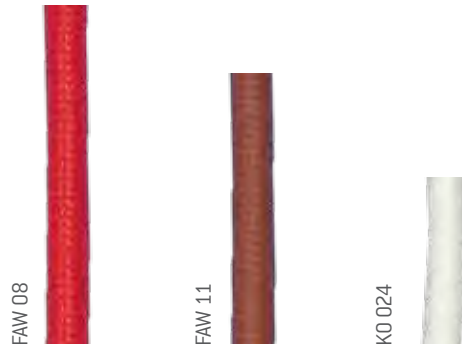

FAW 08

FAW 11

KO 024

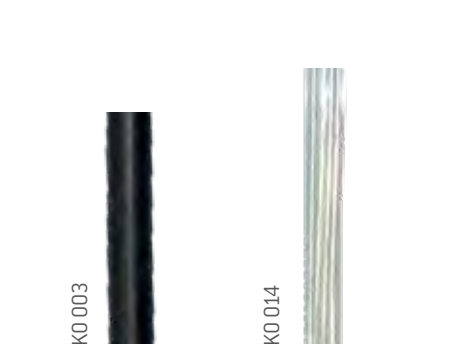

KO 003

KO 014



TECH 13

Nickel plated S/C round support.
Redondo S/C níquel.
Rund S/C Nickel.
Rond S/C nickel.



EK 18

White PVC.
PVC blanco.
PVC Weiß.
PVC blanc.

All El Torrent Il·luminació, sl. products are manufactured according to European regulations UNE-EN 60598-1:05 / UNE-EN 60598-2-1:93 / UNE-EN 60598-2-4:99

El Torrent Il·luminació, sl. reserves the right to make any changes it believes are beneficial to the end product and are in the client's interests. The content of this catalogue is copyright protected.

The total or partial reproduction of the images, text, illustrations and graphic designs included in this catalogue is categorically forbidden, without the express authorization of El Torrent Il·luminació, sl.

Todos los productos de El Torrent Il·luminació, S.L. están fabricados siguiendo las normativas europeas UNE-EN 60598-1:05 / UNE-EN 60598-2-1:93 / UNE-EN 60598-2-4:99

El Torrent Il·luminació, S.L. se reserva el derecho de hacer los cambios que considere oportunos en beneficio del producto final y del cliente. Todo el contenido de este catálogo está protegido por derechos de autor y copyright.

Queda terminantemente prohibida la reproducción total o parcial de las imágenes, textos, ilustraciones y conceptos gráficos sin autorización expresa de El Torrent Il·luminació, S.L.

Alle Produkte von EL Torrent Il·luminació, SL. werden gemäß den europäischen Richtlinien UNE-EN 60598-1:05 / UNE-EN 60598-2-1:93 / UNE-EN 60598-2-4:99 erzeugt.

El Torrent Il·luminació, sl. behält sich das Recht vor, die von ihm für zweckmäßig erachteten Abänderungen zum Vorteil des Endprodukts und des Kunden durchzuführen. Der gesamte Inhalt dieses Katalog ist durch Urheberrechte und Copyright geschützt.

Die teilweise oder ganze Vervielfältigung der Fotos, Texte, Illustrationen und graphischen Konzepte ist ohne ausdrückliche Erlaubnis von El Torrent Il·luminació, sl. ausdrücklich verboten.

Tous les produits de El Torrent Il·luminació, sl. sont fabriqués en suivant les réglementations européennes UNE-EN 60598-1:05 / UNE-EN 60598-2-1:93 / UNE-EN 60598-2-4:99

El Torrent Il·luminació, sl. se réserve le droit de faire les changements jugés nécessaires au bénéfice du produit final et du client. Tout le contenu de ce catalogue est protégé par des droits d'auteur et par copyright.

La reproduction totale ou partielle des images, textes, illustrations et concepts graphiques est formellement interdite sans autorisation expresse de El Torrent Il·luminació, sl.



El Torrent Il·luminació, SL.
C. Curreró, 8 - 17830 Mieres (Girona) Spain
T +34 972 682 037 +34 972 680 291 M +34 691 581 314 F +34 972 680 011
eltorrent@eltorrent.com - www.eltorrent.com

Photography **Fotografía** Fotografie **Photographie** - www.9dotze.com - foto disseny J.E. - Integrum - Francesc Rabat
Design **Diseño** Gestaltung **Design** - www.studidf.com
Digital retouching of spaces **Retoque digital espacios** Digitale Überarbeitung von Räumen **retouche numérique d'espaces** - www.studidf.com
Printing **Impresión** Druck **Impression** - Agpograf
Dip legal - ????????

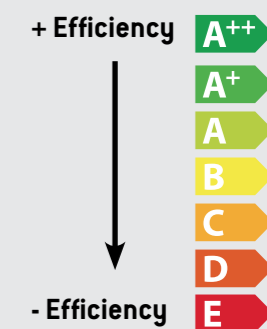

The energy efficiency categories include several types of lamp for reference purposes. Due to a rapidly changing market and the differences between manufacturers we use energy efficiency categories as a guide.

Los intervalos incluyen varias categorías de lámparas como referencia. Debido a los rápidos cambios en el mercado y las diferencias entre fabricantes, utilizamos intervalos como guía.

In unseren Intervallen sind unterschiedliche Lampenkategorien als Artikelnummern geführt. Wir verwenden Intervalle als Leitfaden, um den schnellen Veränderungen am Markt und den Unterschieden zwischen den Herstellern gerecht zu werden.

Les classes comprennent plusieurs catégories de lampes de référence. En raison des fluctuations rapides du marché et des différences entre les fabricants, ces classes sont utilisées comme guide.

